



OBTLIGHTING LIMITED

Catalogue 2026

Think art of light

Lighting design holds great significance as a key element that profoundly influences mood, emotion, and ambiance. A high-quality lighting solution has the power to elevate and enhance your designs to an entirely new realm. When delving into lighting design, we always approach it as an art form—exploring the profound impact of utilizing light and shadow to positively transform the overall atmosphere of a space.

Creating the perfect lighting design has never been easier, thanks to OBT's extensive collection of miniaturized luminaires. With their elegant aesthetic and precise optics, you can effortlessly find the ideal lighting solution to bring your vision to life.



Light and Shadow

Embrace the beauty of contrast: light and shadow intertwine to create a captivating experience. At the heart of our design philosophy lies nature itself. The interplay of natural light is a constant source of inspiration, giving rise to breathtaking scenes, subtle gradients, and delicate effects that exude smoothness and elegance.

Unleashing the power of natural light offers benefits that extend far beyond aesthetics. Exposure to this radiant source helps our bodies produce essential Vitamin D, regulates our circadian rhythms, and improves our sleep patterns. It boosts our focus, productivity, and uplifts our mood, contributing to our overall happiness. Recognizing the significance of this invaluable resource is crucial for our physical and psychological well-being.

When we embark on the design journey, we strive to preserve the innate essence of light within our spaces. We are captivated by the graceful curves it generates, always mindful not to disrupt the natural effects it brings forth.



Design, Quality

At OBT, our team of skilled technicians and engineers work closely with lighting designers, architects, and interior designers throughout the entire process, from conceptualization to installation.

Quality is paramount in our approach. We strive to provide the highest quality of light fittings that perfectly aligns with the unique needs and functions of each environment, ensuring the utmost satisfaction for its occupants and visitors.



Craftsmanship

At OBT, we take pride in our dedication to the art of craftsmanship. Almost 100% of our light fittings are meticulously crafted from pure aluminium using masterful techniques, resulting in a flawless finish that exudes sophistication. Our commitment to boutique aesthetics ensures that every product is a testament to both form and function.

Furthermore, OBT is renowned for its expertise in bespoke product design and manufacturing. Whether for a premium residential or commercial project, we excel at creating tailor-made solutions that perfectly complement the unique requirements and vision of our clients.



Think Art of Light

Original Befuture Technology

OBT upholds the core philosophy of Original Befuture Technology.

We integrate original design with forward-looking technology, focusing on the aesthetics of light and practical functions. With exquisite craftsmanship, we create high-quality lighting products and continuously innovate to optimize lighting experience.

We are committed to providing healthy, comfortable and design-driven lighting solutions for home and commercial spaces, illuminating a better life with original light.

Products Index

Introduction	010
Ron	011
Harrow	033
Kingdom	043
Cabin S	059
Cabin D	069
Cabin R	079
Cabin M	089
Golf	095
Lens	103
OT	109
OT-T	143
Scout	149
Dover	159
LumiPod	165
Micro Track	169
MTA	177
Microline	179
B-O	197

Ron



Great
Visual
Comfort



Ø34

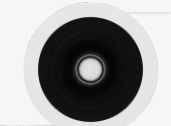

Ø38



Ø61



Ø79



Ron

Installation Instructions

One-piece carriage with integrated heat dissipation and six internal circular holes for top and bottom convection. Adjust the number of cooling fins to meet different illumination requirements.

New thermal design with convection around the perimeter for higher power in a very small size.



Ron

Fixed Recessed

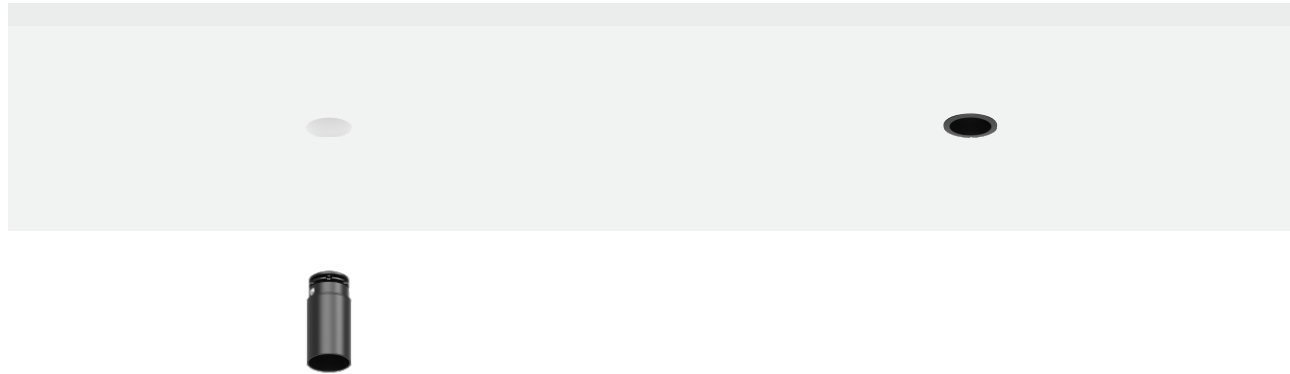

Body

The ultra-compact die-cast aluminum body integrates seamlessly into the ceiling, maintaining a clean, minimalist aesthetic.

Available in fixed configurations with power options starting at 3W. A classic and practical lighting solution with superior optical performance.

Finish

Powder coated finish in white (W), black (B), and chrome (H).

Optional

Trimless



Driver

Supplied with non-dimmable remote driver. Driver unit exceeds luminaire aperture; install above ceiling using extension cable.
Dimming Options: ON/OFF | 0-10V | DALI | TRIAC | CASAMBI.
220-240V 50/60Hz.

Accessories

N/A

Optic

Lens.
Beam Angle: 15° / 24° / 36°.

LED Sources

Light source options: High-power LED or COB LED.
CRI: 95 or 97 | CCT: 2700K / 3000K / 3500K / 4000K / 2700K-6500K (tunable white).
Additional CRI and CCT options available upon request.

Applications

Suitable for all commercial spaces. Transcending traditional lighting methods and effects, it integrates seamlessly into modern environments to achieve the effect of "seeing only the light, not the fixture."

Ron

Fixed Recessed

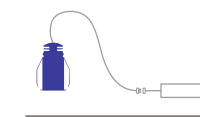
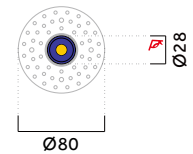
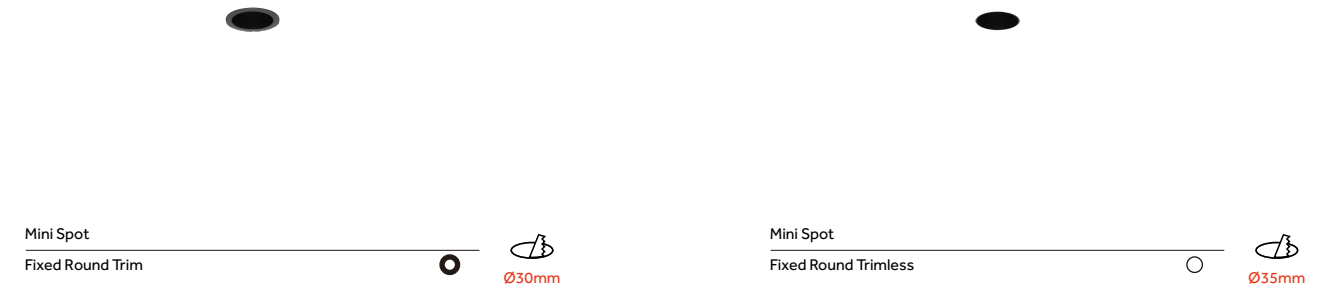
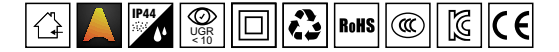

Code ordering example: * * . 3 0 6 1 . * * * * * *

	Product code	LED Power	Nominal Lumen	Finish	Cup	Beam Angle (BA°)	CCT Options	Dimming Options
Mini Spot Round Fixed	01 Trim	Max.3W	240lm	W White	W White	15 15°	27 2700K	0 ON/OFF
	30 Trimless			B Black	B Black	24 24°	30 3000K	1 0-10V
				H Chrome		36 36°	35 3500K	D DAIL
							40 4000K	T TRIAC
							TW 2700K-6500K	C CASAMBI

Ron

Fixed Recessed

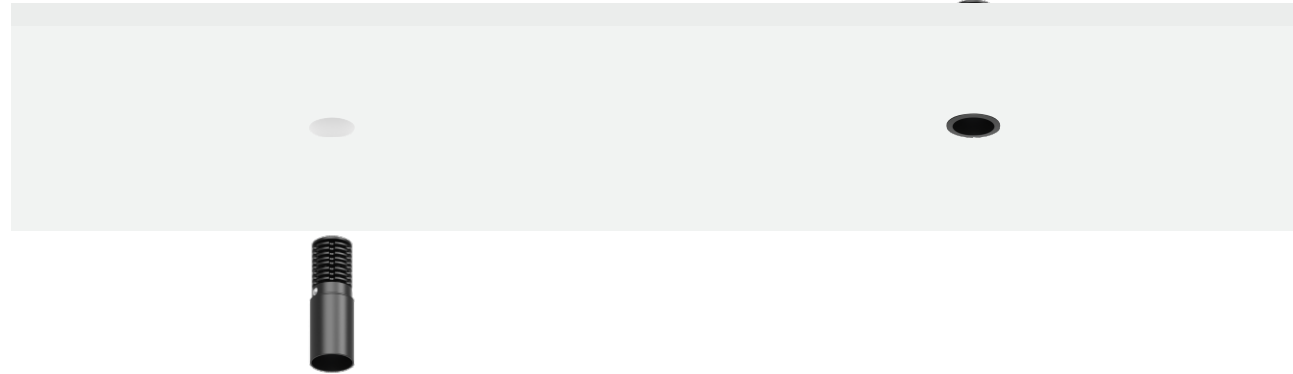

Body

The ultra-compact die-cast aluminum body integrates seamlessly into the ceiling, maintaining a clean, minimalist aesthetic.

Available in fixed configurations with power options starting at 6W. A classic and practical lighting solution with superior optical performance.

Finish

Powder coated finish in white (W), black (B), and chrome (H).

Optional

Trimless



Driver

Supplied with non-dimmable remote driver. Driver unit exceeds luminaire aperture; install above ceiling using extension cable.
Dimming Options: ON/OFF | 0-10V | DALI | TRIAC | CASAMBI.
220-240V 50/60Hz.

Accessories

N/A

Optic

Lens.
Beam Angle: 15° / 24° / 36°.

LED Sources

Light source options: High-power LED or COB LED.
CRI: 95 or 97 | CCT: 2700K / 3000K / 3500K / 4000K / 2700K-6500K (tunable white).
Additional CRI and CCT options available upon request.

Applications

Suitable for all commercial spaces. Transcending traditional lighting methods and effects, it integrates seamlessly into modern environments to achieve the effect of "seeing only the light, not the fixture."

Ron

Fixed Recessed

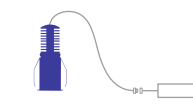
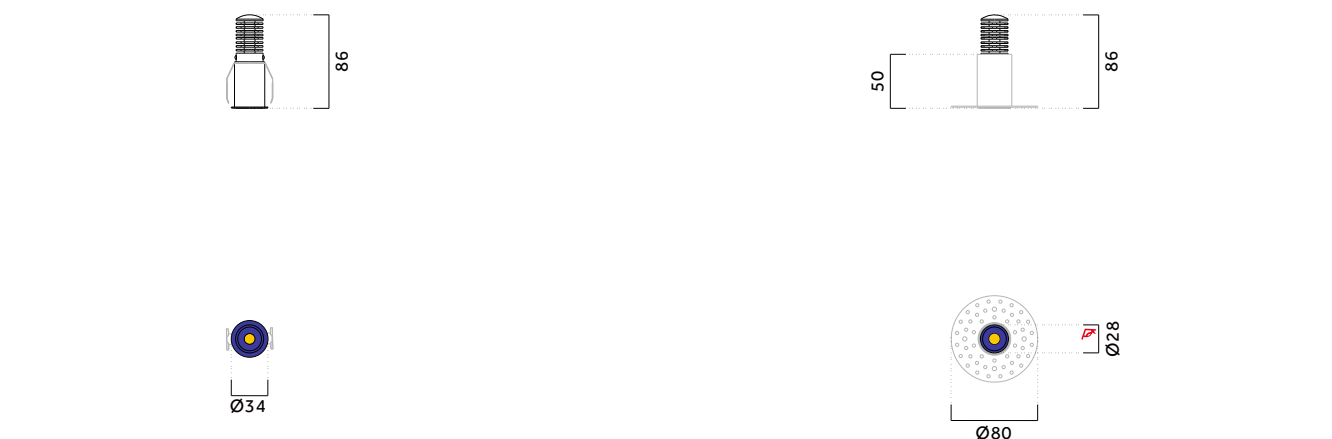
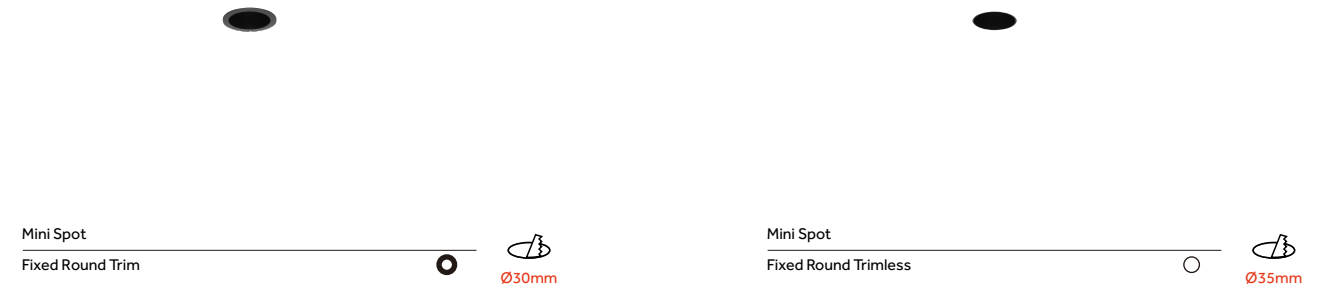
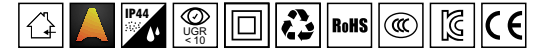

Code ordering example: * * . 3 0 8 6 . * * * * * *

	Product code	LED Power	Nominal Lumen	Finish	Cup	Beam Angle (BA°)	CCT Options	Dimming Options
Mini Spot Round Fixed	01 Trim	Max.6W	480lm	W White	W White	15 15°	27 2700K	0 ON/OFF
	30 Trimless			B Black	B Black	24 24°	30 3000K	1 0-10V
				H Chrome		36 36°	35 3500K	D DALI
							40 4000K	T TRIAC
							TW 2700K-6500K	C CASAMBI

Ron



The light is the breath of space. Between the wood texture, it breathes a quiet and warm atmosphere.

Ron

Adjustable Recessed

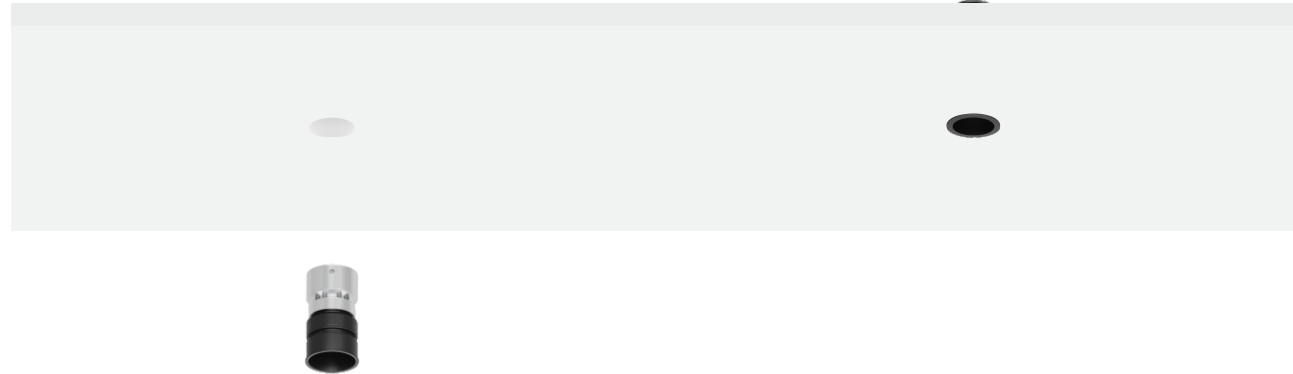

Body

A modular, high-performance recessed downlight featuring a deeply regressed, virtually invisible LED light source that delivers exceptional luminosity with optimal glare control. Its recessed cylindrical housing and circular ceiling trim are precision-crafted from cast aluminum.

With an ultra-thin, narrow bezel design, the luminaire blends seamlessly into the ceiling, creating a sleek and integrated aesthetic.

Optic

Lens.
Beam Angle: 15° / 24° / 36°.

LED Sources

Light source options: High-power LED or COB LED.
CRI: 95 or 97 | CCT: 2700K / 3000K / 3500K / 4000K / 2700K-6500K (tunable white).
Additional CRI and CCT options available upon request.

Finish

Powder coated finish in white (W), black (B).

Optional

Trimless



Driver

Supplied with non-dimmable remote driver.
Driver unit exceeds luminaire aperture; install above ceiling using extension cable.
Dimming Options: ON/OFF | 0-10V | DALI | TRIAC | CASAMBI.
220-240V 50/60Hz.

Accessories

N/A

Applications

The concealed light source ensures high visual comfort and seamless integration into any architectural environment. It offers added flexibility in light aiming.
Application areas: corridors, retail, showrooms, residential, restaurants, hotels.

Ron Adjustable Recessed

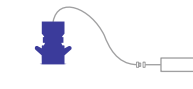
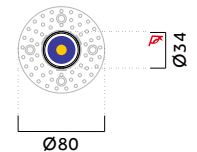
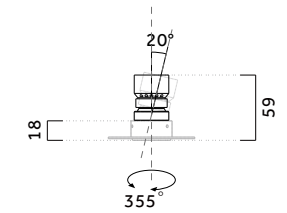
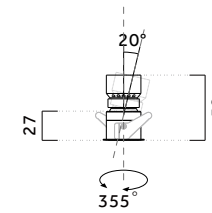
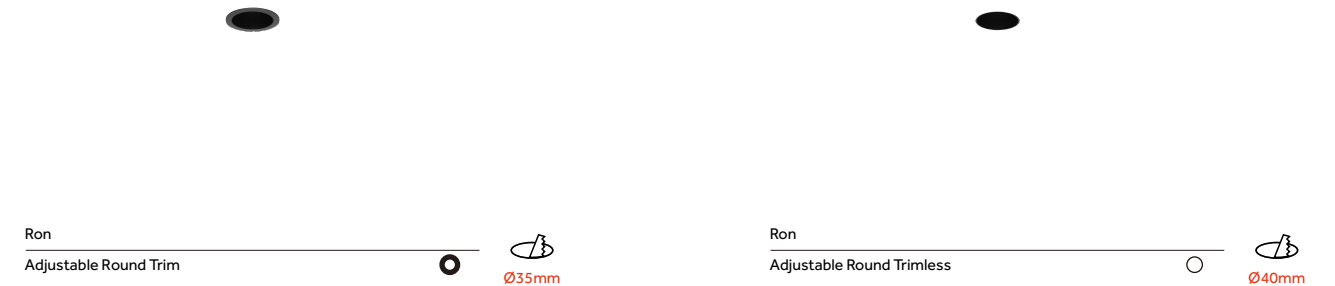
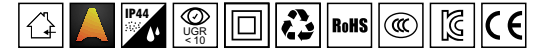

Code ordering example: * * . 3 5 5 9 . * * * * * *

	Product code	LED Power	Nominal Lumen	Finish	Cup	Beam Angle (BA°)	CCT Options	Dimming Options
Ron Round Adjustable	02 Trim	Max.6W	540lm	W White	W White	15 15°	27 2700K	0 ON/OFF
	11 Trimless			B Black	B Black	24 24°	30 3000K	1 0-10V
					G Gold	36 36°	35 3500K	D Dail
					S Silver		40 4000K	T TRIAC
							TW 2700K-6500K	C CASAMBI

Ron

Adjustable Recessed

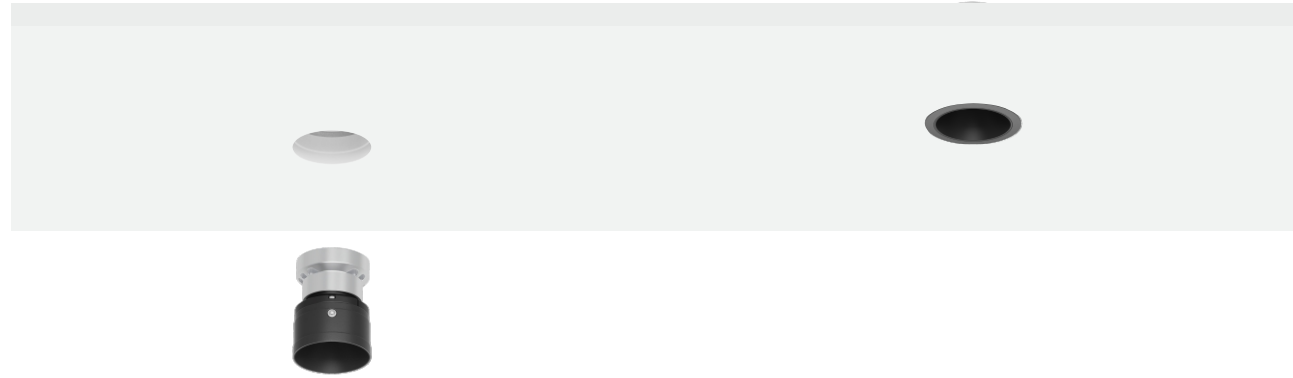

Body

A modular, high-performance recessed downlight featuring a deeply regressed, virtually invisible LED light source that delivers exceptional luminosity with optimal glare control. Its recessed cylindrical housing and circular ceiling trim are precision-crafted from cast aluminum.

With an ultra-thin, narrow bezel design, the luminaire blends seamlessly into the ceiling, creating a sleek and integrated aesthetic.

Optic

Lens.
Beam Angle: 15° / 24° / 36°.

LED Sources

Light source options: High-power LED or COB LED.
CRI: 95 or 97 | CCT: 2700K / 3000K / 3500K / 4000K / 2700K-6500K (tunable white).
Additional CRI and CCT options available upon request.

Finish

Powder coated finish in white (W), black (B).

Optional

Trim



Trimless



Driver

Supplied with non-dimmable remote driver.
Driver unit exceeds luminaire aperture; install above ceiling using extension cable.
Dimming Options: ON/OFF | 0-10V | DALI | TRIAC | CASAMBI.
220-240V 50/60Hz.

Accessories

N/A

Applications

The concealed light source ensures high visual comfort and seamless integration into any architectural environment. It offers added flexibility in light aiming.
Application areas: corridors, retail, showrooms, residential, restaurants, hotels.

Ron Adjustable Recessed

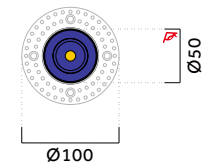
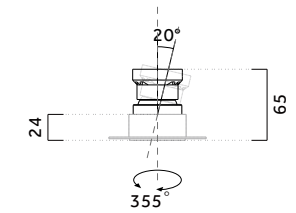
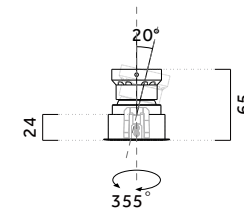
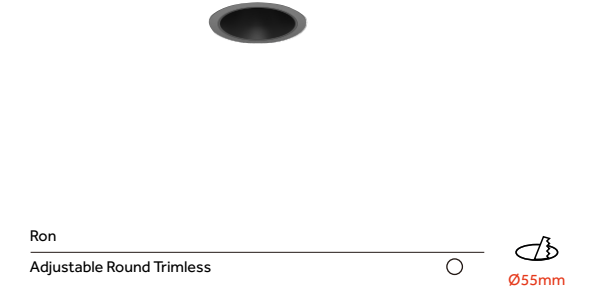
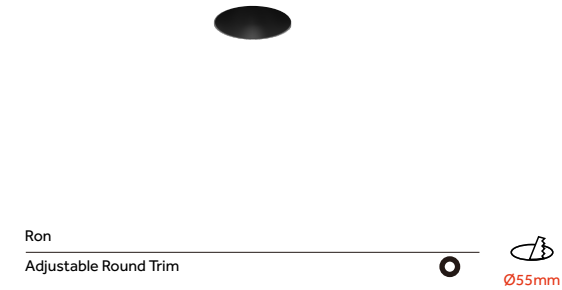
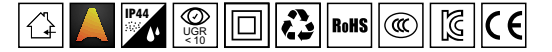

Code ordering example: * * . 5 5 6 5 . * * * * * *

	Product code	LED Power	Nominal Lumen	Finish	Cup	Beam Angle (BA°)	CCT Options	Dimming Options
Ron Round Adjustable	02 Trim	Max.8W	720lm	W White	W White	15 15°	27 2700K	0 ON/OFF
	11 Trimless			B Black	B Black	24 24°	30 3000K	1 0-10V
					G Gold	36 36°	35 3500K	D Dail
					S Silver		40 4000K	T TRIAC
							TW 2700K-6500K	C CASAMBI

Ron

Adjustable Recessed

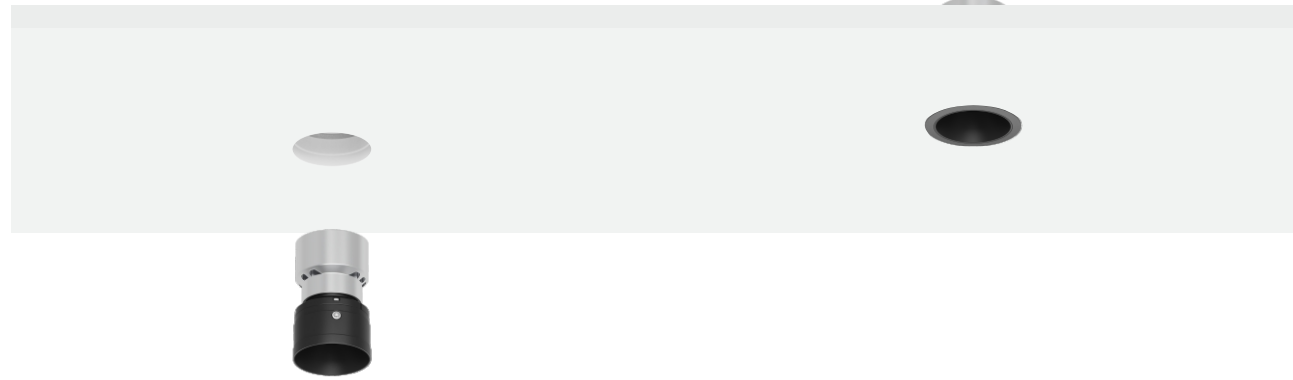

Body

A modular, high-performance recessed downlight featuring a deeply regressed, virtually invisible LED light source that delivers exceptional luminosity with optimal glare control. Its recessed cylindrical housing and circular ceiling trim are precision-crafted from cast aluminum.

With an ultra-thin, narrow bezel design, the luminaire blends seamlessly into the ceiling, creating a sleek and integrated aesthetic.

Finish

Powder coated finish in white (W), black (B).

Optional

Trim

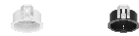

Trimless



Optic

Lens.
Beam Angle: 15° / 24° / 36°.

LED Sources

Light source options: High-power LED or COB LED.
CRI: 95 or 97 | CCT: 2700K / 3000K / 3500K / 4000K / 2700K-6500K (tunable white).
Additional CRI and CCT options available upon request.

Driver

Supplied with non-dimmable remote driver.
Driver unit exceeds luminaire aperture; install above ceiling using extension cable.
Dimming Options: ON/OFF | 0-10V | DALI | TRIAC | CASAMBI.
220-240V 50/60Hz.

Accessories

N/A

Applications

The concealed light source ensures high visual comfort and seamless integration into any architectural environment. It offers added flexibility in light aiming.
Application areas: corridors, retail, showrooms, residential, restaurants, hotels.

Ron Adjustable Recessed

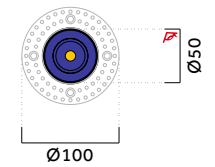
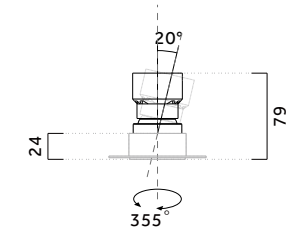
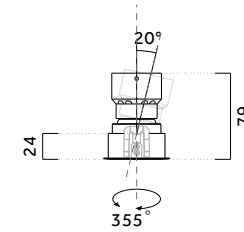
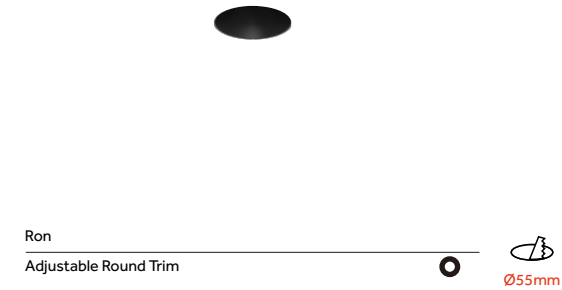
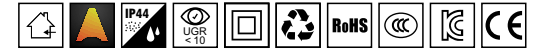

Code ordering example: * * . 5 5 7 9 . * * * * * *

	Product code	LED Power	Nominal Lumen	Finish	Cup	Beam Angle (BA°)	CCT Options	Dimming Options
Ron Round Adjustable	02 Trim	Max.12W	1080lm	W White	W White	15 15°	27 2700K	0 ON/OFF
	11 Trimless			B Black	B Black	24 24°	30 3000K	1 0-10V
					G Gold	36 36°	35 3500K	D Dail
					S Silver		40 4000K	T TRIAC
							TW 2700K-6500K	C CASAMBI

Ron

Adjustable Recessed

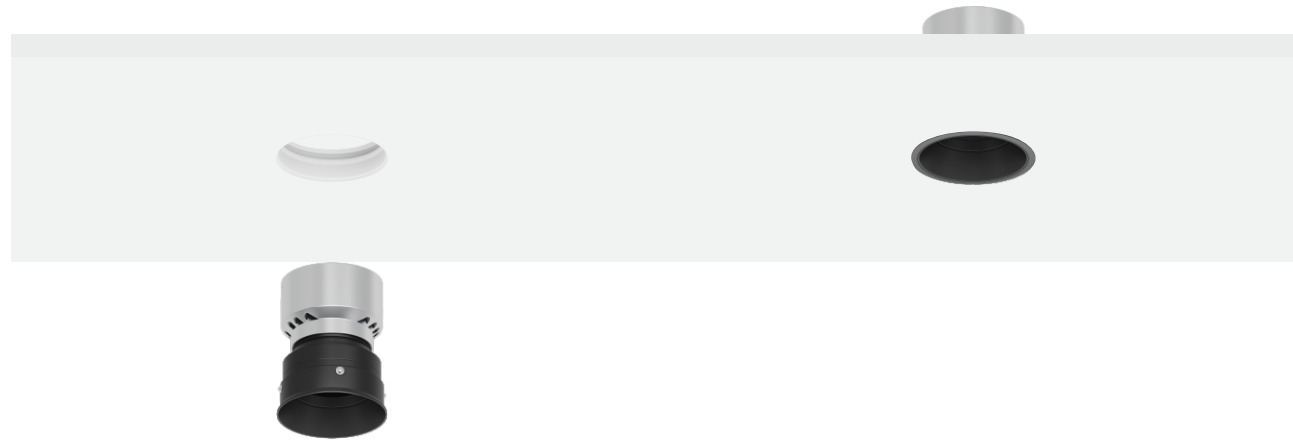

Body

A modular, high-performance recessed downlight featuring a deeply regressed, virtually invisible LED light source that delivers exceptional luminosity with optimal glare control. Its recessed cylindrical housing and circular ceiling trim are precision-crafted from cast aluminum.

With an ultra-thin, narrow bezel design, the luminaire blends seamlessly into the ceiling, creating a sleek and integrated aesthetic.

Finish

Powder coated finish in white (W), black (B).

Optional



Driver

Supplied with non-dimmable remote driver. Driver unit exceeds luminaire aperture; install above ceiling using extension cable.
Dimming Options: ON/OFF | 0-10V | DALI | TRIAC | CASAMBI.
220-240V 50/60Hz.

Accessories

N/A

Optic

Lens.
Beam Angle: 15° / 24° / 36°.

LED Sources

Light source options: High-power LED or COB LED.
CRI: 95 or 97 | CCT: 2700K / 3000K / 3500K / 4000K / 2700K-6500K (tunable white).
Additional CRI and CCT options available upon request.

Applications

The concealed light source ensures high visual comfort and seamless integration into any architectural environment. It offers added flexibility in light aiming.
Application areas: corridors, retail, showrooms, residential, restaurants, hotels.

Ron Adjustable Recessed

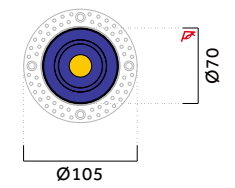
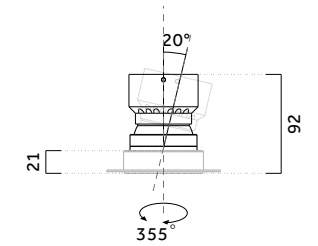
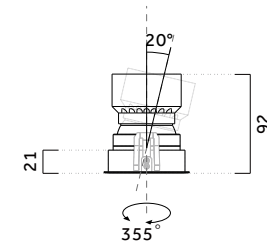
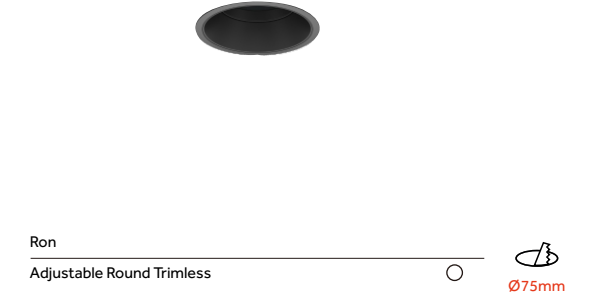
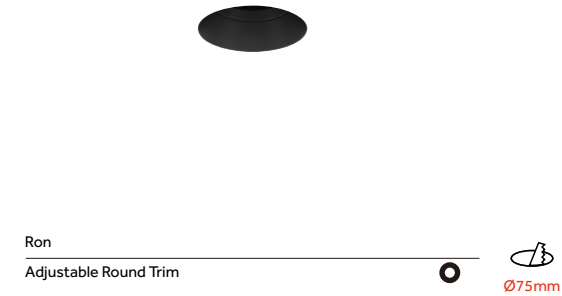
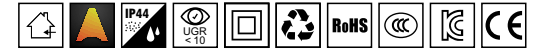

Code ordering example: * * . 7 5 9 2 . * * * * * *

	Product code	LED Power	Nominal Lumen	Finish	Cup	Beam Angle (BA°)	CCT Options	Dimming Options
Ron Round Adjustable	02 Trim	Max.15W	1350lm	W White	W White	15 15°	27 2700K	0 ON/OFF
	11 Trimless			B Black	B Black	24 24°	30 3000K	1 0-10V
					G Gold	36 36°	35 3500K	D Dail
					S Silver		40 4000K	T TRIAC
							TW 2700K-6500K	C CASAMBI



Ron



Square



Ron

Adjustable Recessed

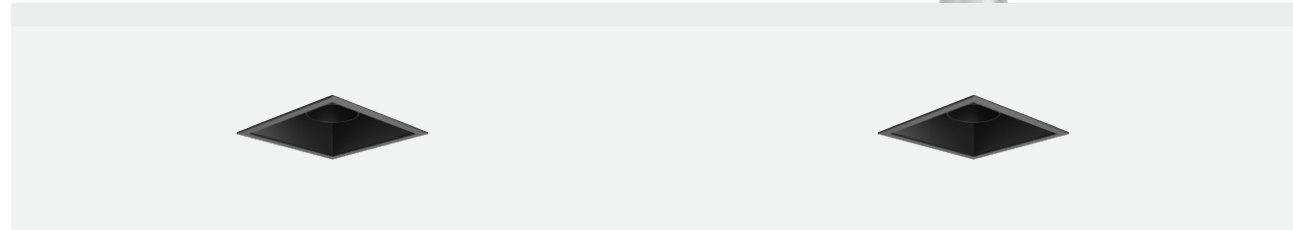

Body

A square mounting trim in cast aluminum with spring-loaded installation brackets for ceiling mounting.

Luminaire body inclusive of snoot in cast aluminum. Tilttable up to 20° in two directions.

Finish

Powder coated finish in white (W), black (B).

Optional

N/A

Driver

Supplied with non-dimmable remote driver. Driver unit exceeds luminaire aperture; install above ceiling using extension cable.
Dimming Options: ON/OFF | 0-10V | DALI | TRIAC | CASAMBI.
220-240V 50/60Hz.

Optic

Lens.
Beam Angle: 15° / 24° / 36° / 50°.

LED Sources

Light source options: High-power LED or COB LED.
CRI: 95 or 97 | CCT: 2700K / 3000K / 3500K / 4000K / 2700K-6500K (tunable white).
Additional CRI and CCT options available upon request.

Applications

Suitable for all commercial environments. Transcends traditional lighting approaches to integrate seamlessly into contemporary architecture—achieving the effect of "seeing the light, not the luminaire.."

Ron Adjustable Recessed

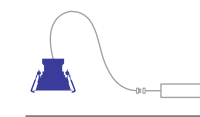
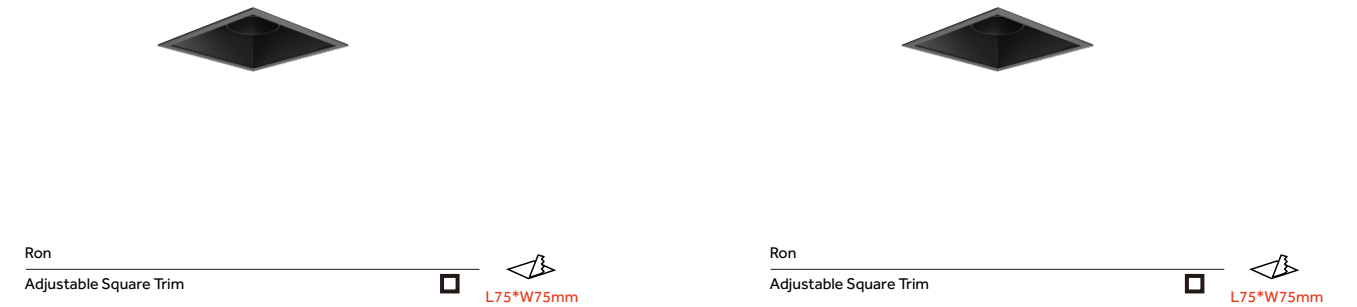
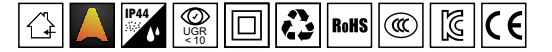

Code ordering example: *** * . 7 5 5 8 . * * * * * *** (Max.8W) *** * . 7 5 7 2 . * * * * * *** (Max.12W)

	Product code	LED Power	Nominal Lumen	Finish	Cup	Beam Angle (BA°)	CCT Options	Dimming Options
Ron Square Adjustable	02 Trim	Max.8W	640lm	W White	W White	15 15°	27 2700K	0 ON/OFF
		Max.12W	960lm	B Black	B Black	24 24°	30 3000K	1 0-10V
						36 36°	35 3500K	D Dail
						50 50°	40 4000K	T TRIAC
						TW 2700K-6500K	C CASAMBI	

Adjustable
round recessed
luminaire

The fixture are rotatable
horizontally 355° and, tiltable
vertically in two directions up to 35°.



HARROW

Harrow

Harrow is the ultimate motorized recessed downlight designed to empower lighting designers with unlimited creative freedom.

DC motors enable a remarkable range of movement, making it an excellent accent lighting solution for restaurants, hotels, and residential lifestyle spaces.



Charrow

Harrow

Adjustable Recessed



Body

These adjustable luminaires are perfect for extraordinary accent lighting in varied settings. Featuring excellent luminous efficiency and an exclusive aesthetic, they come with multiple optics and a wide range of accessories.

With their ultra-thin and narrow border design, our luminaires seamlessly blend with the ceiling, creating a sleek and integrated look.

Finish

Powder coated finish in white (W), black (B).

Optional



Optic

Lens.
Beam Angle: 15° / 24° / 36° / 50°.

Driver

Supplied with non-dimmable remote driver.
Driver unit exceeds luminaire aperture; install above ceiling using extension cable.
Dimming Options: ON/OFF | 0-10V | DALI | TRIAC | CASAMBI.
220-240V 50/60Hz.

Accessories

N/A

LED Sources

Light source options: High-power LED or COB LED.
CRI: 95 or 97 | CCT: 2700K / 3000K / 3500K / 4000K.
Additional CRI and CCT options available upon request.

Applications

Its concealed light source for high visual comfort ensures this luminaire blends seamlessly into its architectural environment. With the added flexibility of light aiming.
Application areas: Corridors, retail, showrooms, residential, restaurants, hotels.

Harrow

Adjustable Recessed

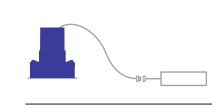
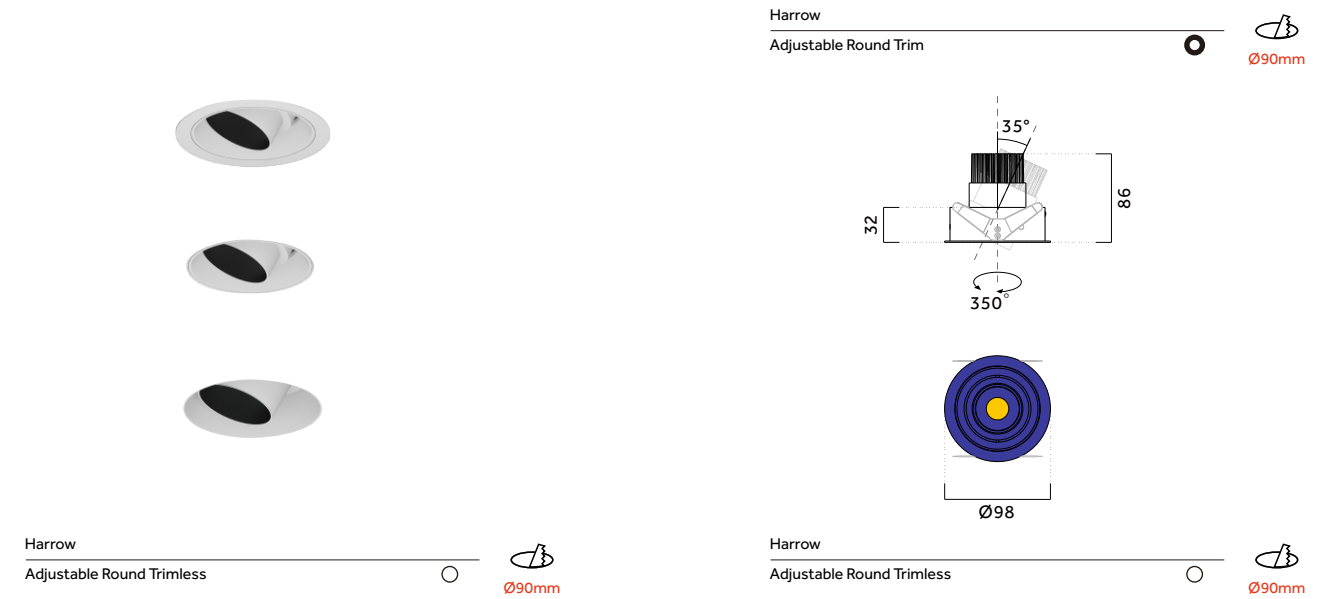

Code ordering example: **** . 9 0 0 1 . *** (Trim) **** . 9 0 0 2 . *** (Trimless Round) **** . 9 0 0 3 . *** (Trimless Adjustable Arm)

	Product code	LED Power	Nominal Lumen	Finish	Cup	Beam Angle (BA°)	CCT Options	Dimming Options
Harrow Round Adjustable	02 Trim	Max.10W	1000lm	W White	W White	15 15°	27 2700K	0 ON/OFF
	11 Trimless			B Black	B Black	24 24°	30 3000K	1 0-10V
						36 36°	35 3500K	D DAIL
						50 50°	40 4000K	T TRIAC C CASAMBI

Harrow

Adjustable Recessed

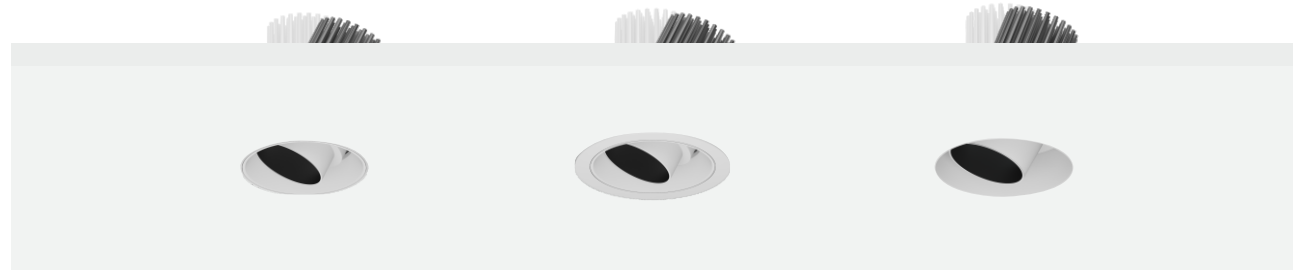

Body

These adjustable luminaires are perfect for extraordinary accent lighting in varied settings. Featuring excellent luminous efficiency and an exclusive aesthetic, they come with multiple optics and a wide range of accessories.

With their ultra-thin and narrow border design, our luminaires seamlessly blend with the ceiling, creating a sleek and integrated look.

Finish

Powder coated finish in white (W), black (B).

Optional



Optic

Lens.
Beam Angle: 15° / 24° / 36° / 50°.

Driver

Supplied with non-dimmable remote driver.
Driver unit exceeds luminaire aperture; install above ceiling using extension cable.
Dimming Options: ON/OFF | 0-10V | DALI | TRIAC | CASAMBI.
220-240V 50/60Hz.

Accessories

N/A

LED Sources

Light source options: High-power LED or COB LED.
CRI: 95 or 97 | CCT: 2700K / 3000K / 3500K / 4000K.
Additional CRI and CCT options available upon request.

Applications

Its concealed light source for high visual comfort ensures this luminaire blends seamlessly into its architectural environment. With the added flexibility of light aiming.
Application areas: Corridors, retail, showrooms, residential, restaurants, hotels.

Harrow

Adjustable Recessed

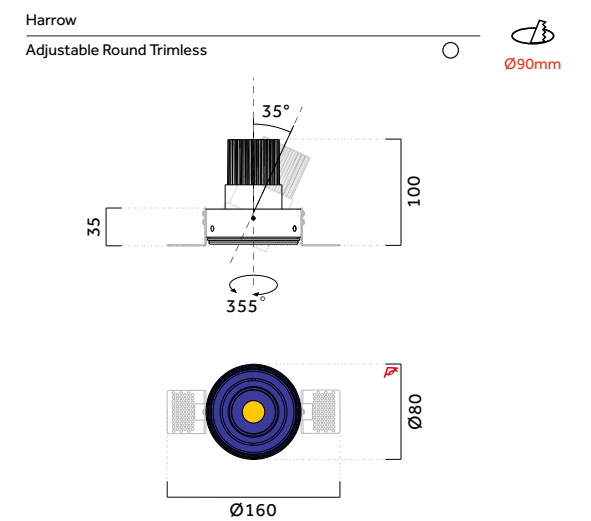
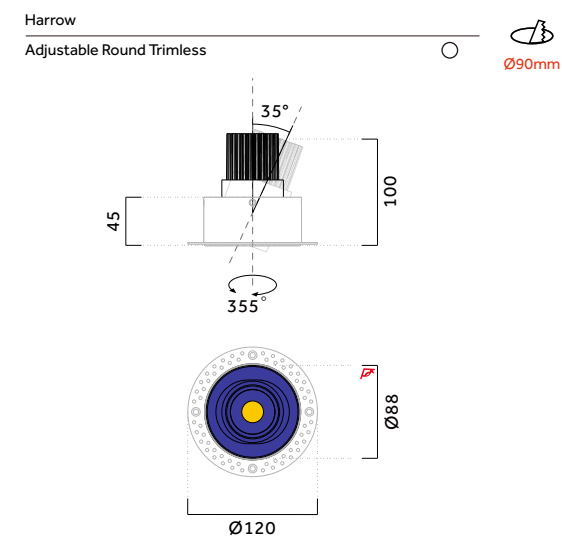

Code ordering example: **** . 9 0 0 4 . *** (Trim) **** . 9 0 0 5 . *** (Trimless Round)
**** . 9 0 0 6 . *** (Trimless Adjustable Arm)

	Product code	LED Power	Nominal Lumen	Finish	Cup	Beam Angle (BA°)	CCT Options	Dimming Options
Harrow Round Adjustable	02 Trim	Max.15W	1500lm	W White	W White	15 15°	27 2700K	0 ON/OFF
	11 Trimless			B Black	B Black	24 24°	30 3000K	1 0-10V
						36 36°	35 3500K	D DALI
						50 50°	40 4000K	T TRIAC C CASAMBI

Harrow

Adjustable Recessed

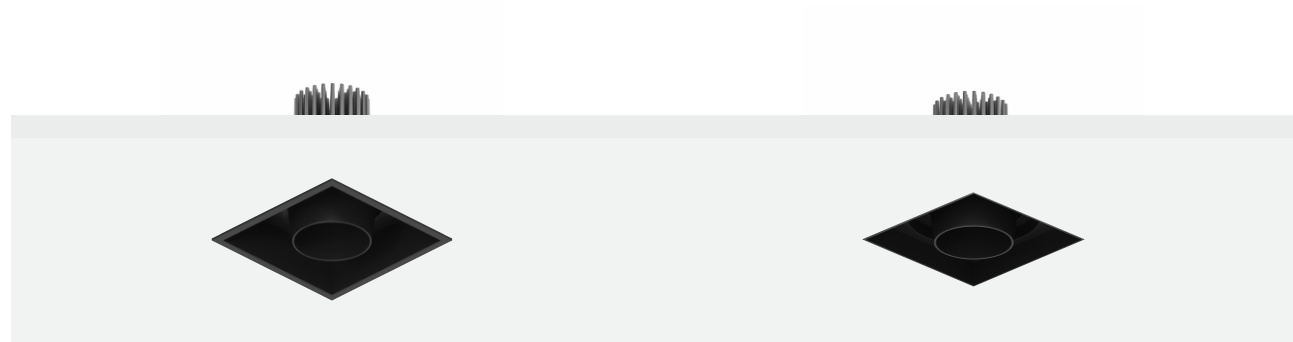

Body

Featuring high-definition recessed optics housed in metallic-finish thermoplastic and integrated with an anti-glare screen for exceptional visual comfort during positioning.

Designed for flush mounting in false ceilings (1-25 mm thickness) with a reliable steel spring mounting system.

The adjustable lamp body includes an extruded aluminum heat sink and provides $\pm 30^\circ$ horizontal tilt plus 355° rotation, all supported by a robust external die-cast aluminum frame.

Optic

Lens.
Beam Angle: $15^\circ / 24^\circ / 36^\circ / 50^\circ$.

LED Sources

Light source options: High-power LED or COB LED.
CRI: 95 or 97 | CCT: 2700K / 3000K / 3500K / 4000K.
Additional CRI and CCT options available upon request.

Finish

Powder coated finish in white (W), black (B).

Optional

N/A

Driver

Supplied with non-dimmable remote driver.
Driver unit exceeds luminaire aperture; install above ceiling using extension cable.
Dimming Options: ON/OFF | 0-10V | DALI | TRIAC | CASAMBI.
220-240V 50/60Hz.

Accessories

N/A

Applications

Its concealed light source for high visual comfort ensures this luminaire blends seamlessly into its architectural environment. With the added flexibility of light aiming.
Application areas: Corridors, retail, showrooms, residential, restaurants, hotels.

Harrow

Adjustable Recessed

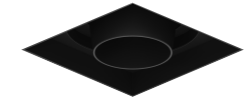
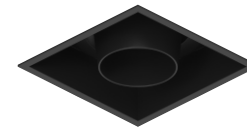
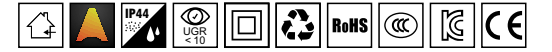

Ron
Adjustable Square Trim L100*W100mm

Ron
Adjustable Square Trimless L100*W100mm

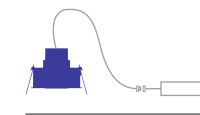
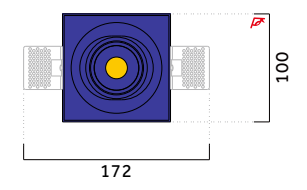
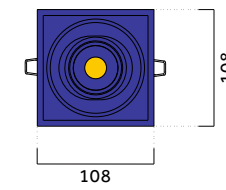
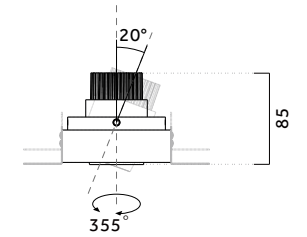
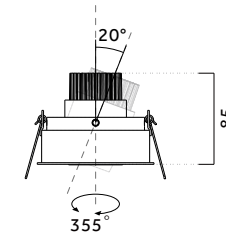

Code ordering example: * * . 1 0 8 5 . * * * * * *

	Product code	LED Power	Nominal Lumen	Finish	Cup	Beam Angle (BA°)	CCT Options	Dimming Options
Harrow Square Adjustable	02 Trim	Max.10W	1000lm	W White	W White	15 15°	27 2700K	0 ON/OFF
	11 Trimless			B Black	B Black	24 24°	30 3000K	1 0-10V
						36 36°	35 3500K	D Dail
						50 50°	40 4000K	T TRIAC C CASAMBI

Harrow

Adjustable Recessed

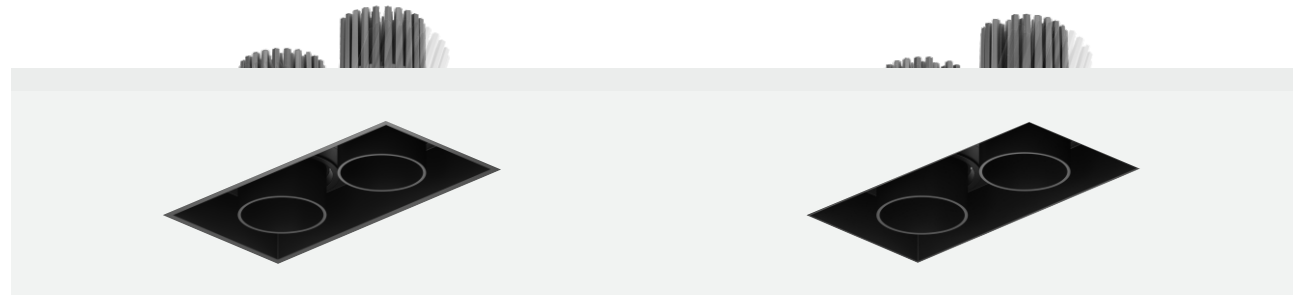

Body

Featuring high-definition recessed optics housed in metallic-finish thermoplastic and integrated with an anti-glare screen for exceptional visual comfort during positioning.

Designed for flush mounting in false ceilings (1-25 mm thickness) with a reliable steel spring mounting system.

The adjustable lamp body includes an extruded aluminum heat sink and provides $\pm 30^\circ$ horizontal tilt plus 355° rotation, all supported by a robust external die-cast aluminum frame.

Optic

Lens.
Beam Angle: $15^\circ / 24^\circ / 36^\circ / 50^\circ$.

LED Sources

Light source options: High-power LED or COB LED.
CRI: 95 or 97 | CCT: 2700K / 3000K / 3500K / 4000K.
Additional CRI and CCT options available upon request.

Finish

Powder coated finish in white (W), black (B).

Optional

N/A

Driver

Supplied with non-dimmable remote driver.
Driver unit exceeds luminaire aperture; install above ceiling using extension cable.
Dimming Options: ON/OFF | 0-10V | DALI | TRIAC | CASAMBI.
220-240V 50/60Hz.

Accessories

N/A

Applications

Its concealed light source for high visual comfort ensures this luminaire blends seamlessly into its architectural environment. With the added flexibility of light aiming.
Application areas: Corridors, retail, showrooms, residential, restaurants, hotels.

Harrow

Adjustable Recessed

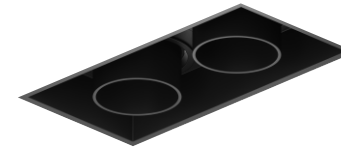

Ron
Adjustable Square Trim L200*W100mm

Ron
Adjustable Square Trimless L200*W100mm

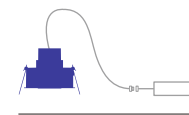
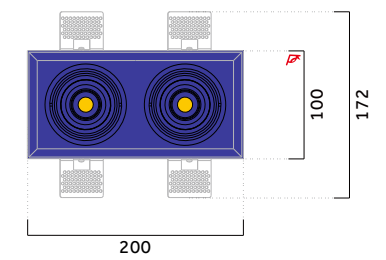
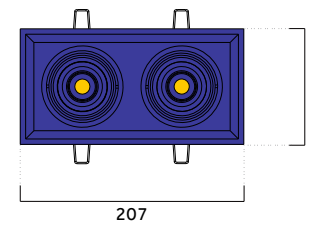
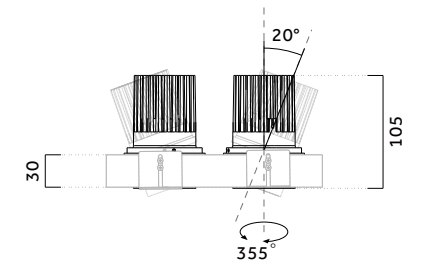
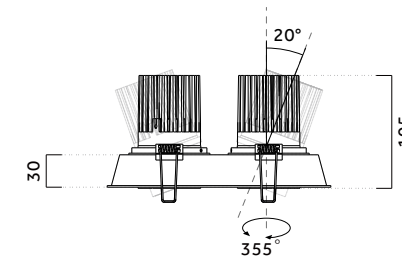

Code ordering example: * * . 2 0 0 5 . * * * * * *

	Product code	LED Power	Nominal Lumen	Finish	Cup	Beam Angle (BA°)	CCT Options	Dimming Options
Harrow Square Adjustable	02 Trim	Max.2*15W	3000lm	W White	W White	15 15°	27 2700K	0 ON/OFF
	11 Trimless			B Black	B Black	24 24°	30 3000K	1 0-10V
						36 36°	35 3500K	D Dail
						50 50°	40 4000K	T TRIAC C CASAMBI

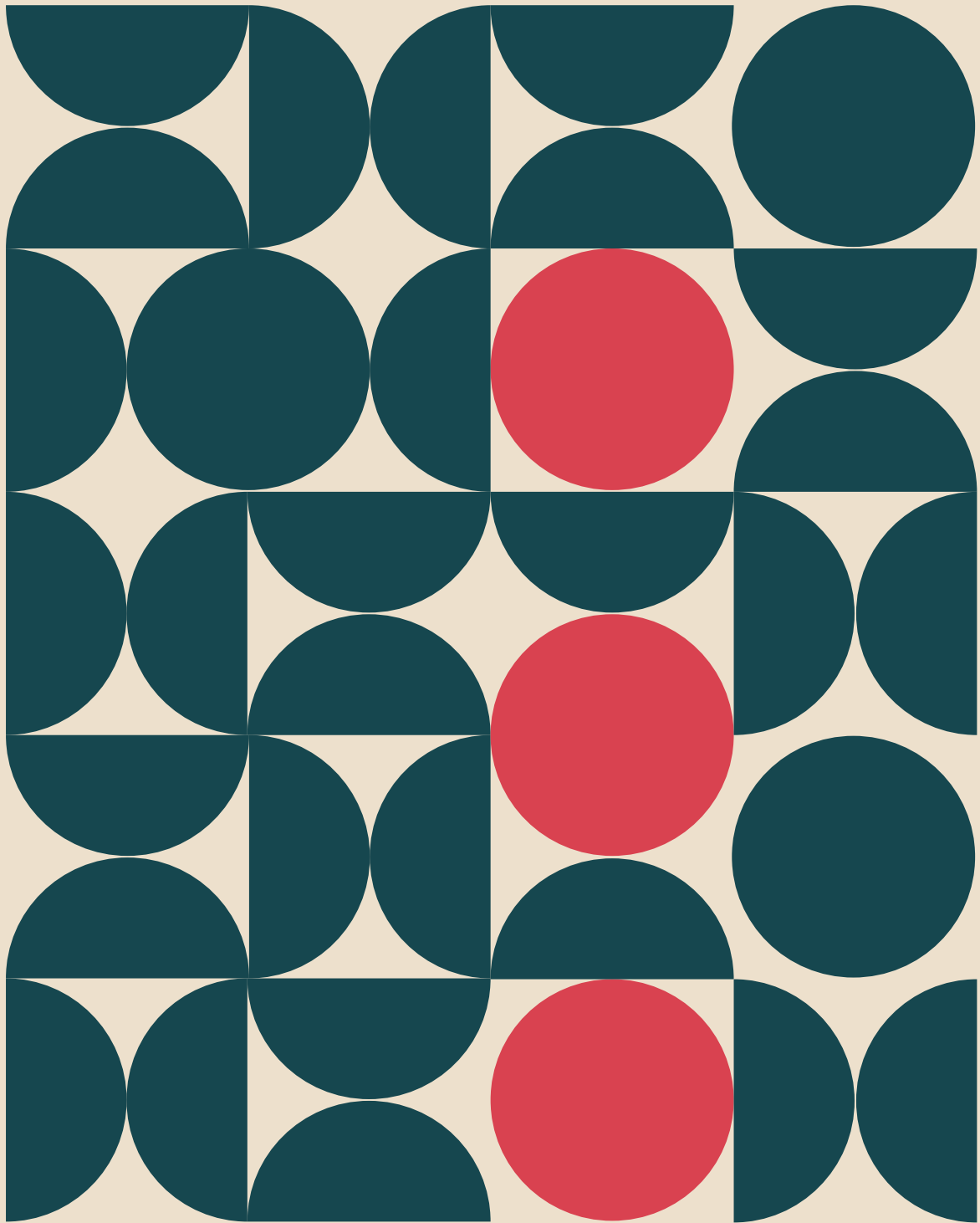

KINGDOM

COMBINATION
SEPT. 09/2025



KINGDOM

Design Origin From Sketch to Product Language



Vertical Fin Design
Derived from sketch lines, it integrates efficient cooling structure with natural textures of leaf veins and bamboo, blending function and aesthetics.

Linear Multi-Cell Light Output
Developed from recessed installation, it features a minimalist modular design for precise zoning and accent lighting.

Kingdom

Fixed Recessed

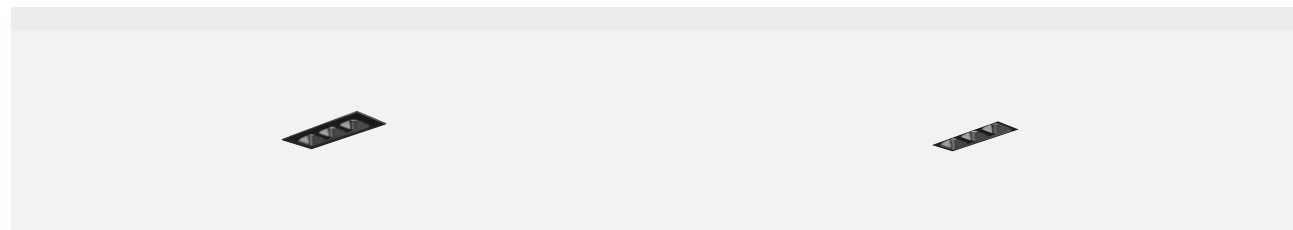

Body

Mounting Trim Rectangular cast aluminum mounting trim featuring spring-loaded clips for trim installation on ceiling thicknesses of 2–25mm, or optional brackets for trimless installation within the same thickness range.

LED Configurations Available in standard light head configurations with 3, 4, 5, or 9 LEDs.

Finish

Powder coated finish in white (W), black (B).

Optional

Trimless



Driver

Supplied with non-dimmable remote driver. Driver unit exceeds luminaire aperture; install above ceiling using extension cable. Dimming Options: ON/OFF | 0-10V | DALI | TRIAC | CASAMBI. 220-240V 50/60Hz.

Accessories

N/A

Optic

Reflector. Beam Angle: 24° / 36°.

LED Sources

Light source options: High-power LED or COB LED. CRI: 95 or 97 | CCT: 2700K / 3000K / 3500K / 4000K / 2700K–6500K (tunable white). Additional CRI and CCT options available upon request.

Applications

An innovative solution for high performance, uniform illumination with optimal visual comfort. The miniature light heads and optics create a high definition, glare-controlled, circular light emission. Application areas: residential, hotels, restaurants, retail, corridors.

Kingdom

Fixed Recessed



Kingdom
Fixed Square Trim L61*W22mm

Kingdom
Fixed Square Trimless L63*W24mm

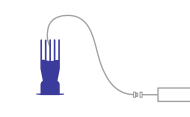
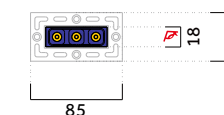
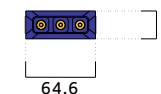

Code ordering example: . 6 1 5 2 .

	Product code	LED Power	Nominal Lumen	Finish	Cup	Beam Angle (BA°)	CCT Options	Dimming Options
Kingdom Fixed	01 Trim	Max.6W	600lm	W White	W White	24 24°	27 2700K	0 ON/OFF
	30 Trimless			B Black	B Black	36 36°	30 3000K	1 0-10V
							35 3500K	D DAIL
							40 4000K	T TRIAC
						TW 2700K-6500K	C CASAMBI	

Kingdom

Fixed Recessed

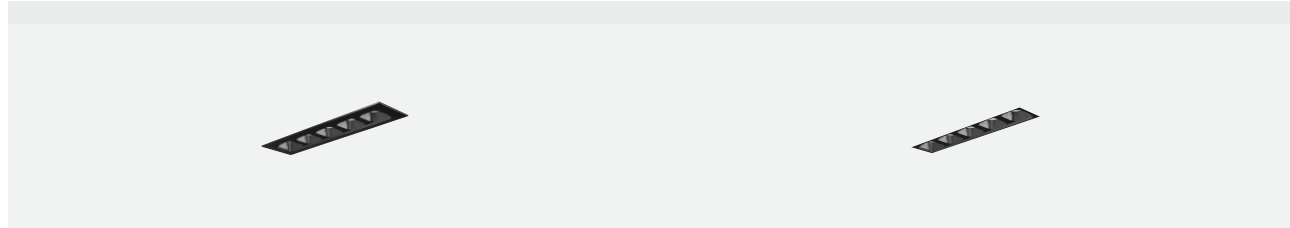

Body

Mounting Trim Rectangular cast aluminum mounting trim featuring spring-loaded clips for trim installation on ceiling thicknesses of 2–25mm, or optional brackets for trimless installation within the same thickness range.

LED Configurations Available in standard light head configurations with 3, 4, 5, or 9 LEDs.

Finish

Powder coated finish in white (W), black (B).

Optional

Trimless



Driver

Supplied with non-dimmable remote driver. Driver unit exceeds luminaire aperture; install above ceiling using extension cable.
Dimming Options: ON/OFF | 0-10V | DALI | TRIAC | CASAMBI.
220-240V 50/60Hz.

Accessories

N/A

Optic

Reflector.
Beam Angle: 24° / 36°.

LED Sources

Light source options: High-power LED or COB LED.
CRI: 95 or 97 | CCT: 2700K / 3000K / 3500K / 4000K / 2700K–6500K (tunable white).
Additional CRI and CCT options available upon request.

Applications

An innovative solution for high performance, uniform illumination with optimal visual comfort. The miniature light heads and optics create a high definition, glare-controlled, circular light emission.
Application areas: residential, hotels, restaurants, retail, corridors.

Kingdom

Fixed Recessed

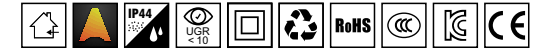

Kingdom
Fixed Square Trim  L97*W22mm

Kingdom
Fixed Square Trimless  L99*W24mm

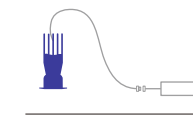
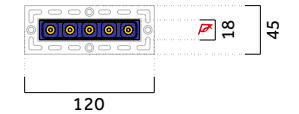
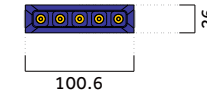
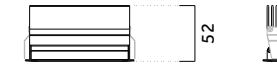

Code ordering example: * * . 9 7 5 2 . * * * * * *

	Product code	LED Power	Nominal Lumen	Finish	Cup	Beam Angle (BA°)	CCT Options	Dimming Options
Kingdom Fixed	01 Trim	Max.10W	1000lm	W White	W White	24 24°	27 2700K	0 ON/OFF
	30 Trimless			B Black	B Black	36 36°	30 3000K	1 0-10V
							35 3500K	D DAIL
							40 4000K	T TRIAC
							TW 2700K-6500K	C CASAMBI

Kingdom

Fixed Recessed

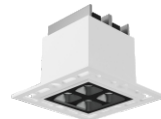
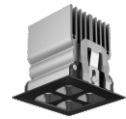
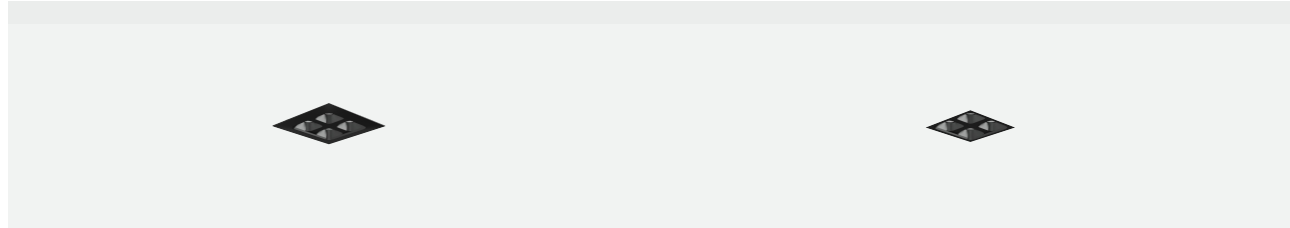

Body

Mounting Trim Rectangular cast aluminum mounting trim featuring spring-loaded clips for trim installation on ceiling thicknesses of 2–25mm, or optional brackets for trimless installation within the same thickness range.

LED Configurations Available in standard light head configurations with 3, 4, 5, or 9 LEDs.

Finish

Powder coated finish in white (W), black (B).

Optional

Trimless



Driver

Supplied with non-dimmable remote driver. Driver unit exceeds luminaire aperture; install above ceiling using extension cable. Dimming Options: ON/OFF | 0-10V | DALI | TRIAC | CASAMBI. 220-240V 50/60Hz.

Accessories

N/A

Optic

Reflector. Beam Angle: 24° / 36°.

LED Sources

Light source options: High-power LED or COB LED. CRI: 95 or 97 | CCT: 2700K / 3000K / 3500K / 4000K / 2700K–6500K (tunable white). Additional CRI and CCT options available upon request.

Applications

An innovative solution for high performance, uniform illumination with optimal visual comfort. The miniature light heads and optics create a high definition, glare-controlled, circular light emission. Application areas: residential, hotels, restaurants, retail, corridors.

Kingdom

Fixed Recessed

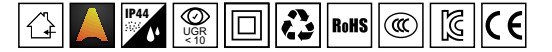

Kingdom
Fixed Square Trim  **L47*W39mm**

Kingdom
Fixed Square Trimless  **L45*W45mm**

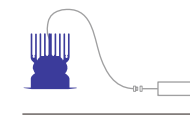
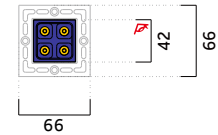
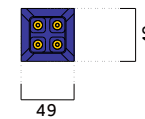
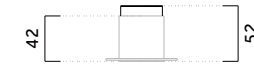

Code ordering example: . 4 7 5 2 .

	Product code	LED Power	Nominal Lumen	Finish	Cup	Beam Angle (BA°)	CCT Options	Dimming Options
Kingdom Fixed	01 Trim	Max.8W	800lm	W White	W White	24 24°	27 2700K	0 ON/OFF
	30 Trimless			B Black	B Black	36 36°	30 3000K	1 0-10V
						35 3500K	D DAIL	
						40 4000K	T TRIAC	
						TW 2700K-6500K	C CASAMBI	

Kingdom

Fixed Recessed

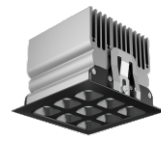
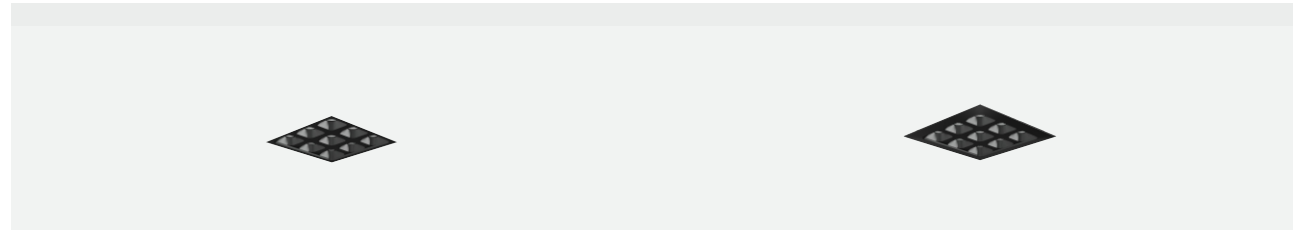

Body

Mounting Trim Rectangular cast aluminum mounting trim featuring spring-loaded clips for trim installation on ceiling thicknesses of 2–25mm, or optional brackets for trimless installation within the same thickness range.

LED Configurations Available in standard light head configurations with 3, 4, 5, or 9 LEDs.

Finish

Powder coated finish in white (W), black (B).

Optional

Trimless



Driver

Supplied with non-dimmable remote driver. Driver unit exceeds luminaire aperture; install above ceiling using extension cable. Dimming Options: ON/OFF | 0-10V | DALI | TRIAC | CASAMBI. 220-240V 50/60Hz.

Accessories

N/A

Optic

Reflector. Beam Angle: 24° / 36°.

LED Sources

Light source options: High-power LED or COB LED. CRI: 95 or 97 | CCT: 2700K / 3000K / 3500K / 4000K / 2700K–6500K (tunable white). Additional CRI and CCT options available upon request.

Applications

An innovative solution for high performance, uniform illumination with optimal visual comfort. The miniature light heads and optics create a high definition, glare-controlled, circular light emission. Application areas: residential, hotels, restaurants, retail, corridors.

Kingdom

Fixed Recessed

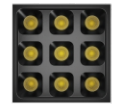
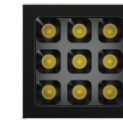
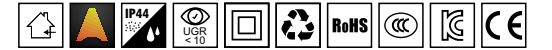

Kingdom
Fixed Square Trim L64*W57mm

Kingdom
Fixed Square Trimless L63*W63mm

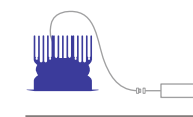
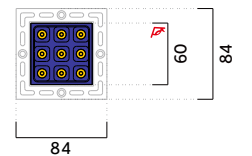
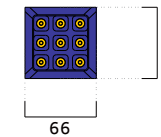

Code ordering example: * * . 6 4 5 2 . * * * * * *

	Product code	LED Power	Nominal Lumen	Finish	Cup	Beam Angle (BA°)	CCT Options	Dimming Options
Kingdom Fixed	01 Trim	Max.16W	1600lm	W White	W White	24 24°	27 2700K	0 ON/OFF
	30 Trimless			B Black	B Black	36 36°	30 3000K	1 0-10V
							35 3500K	D DAIL
							40 4000K	T TRIAC
							TW 2700K-6500K	C CASAMBI

Kingdom

Fixed Recessed

ULTIMATE COMFORT

With a UGR below 10, it offers optimal glare protection, enabling a more comfortable and natural visual experience. Its advanced optical technology ensures homogeneous light distribution, eliminating excessive contrasts and unwanted shadows.



Kingdom

Fixed Recessed

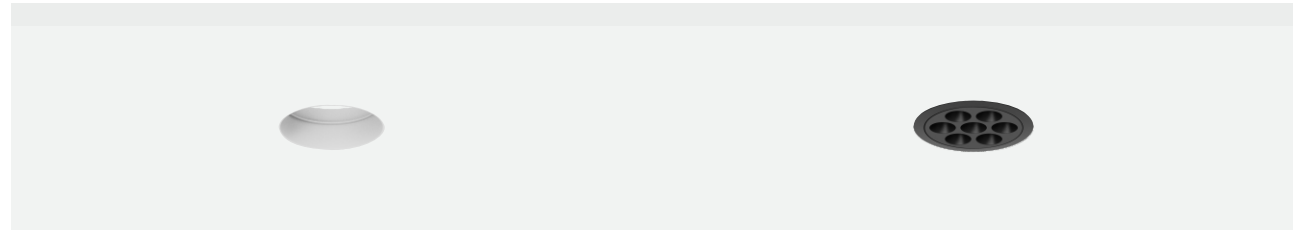

Body

Kingdom represents a breakthrough in architectural lighting. Its ultra-compact design enables versatile installation across various ceiling types, including shallow false ceilings where traditional solutions are not suitable.

Offering a range of refined finishes, including premium metallic options, these luminaires serve as both lighting sources and decorative elements, bringing an elegant, distinctive design touch to any space.

Optic

Reflector.
Beam Angle: 24° / 36°.

LED Sources

Light source options: High-power LED or COB LED.
CRI: 95 or 97 | CCT: 2700K / 3000K / 3500K / 4000K / 2700K-6500K (tunable white).
Additional CRI and CCT options available upon request.

Finish

Powder coated finish in white (W), black (B).

Driver

Supplied with non-dimmable remote driver.
Driver unit exceeds luminaire aperture; install above ceiling using extension cable.
Dimming Options: ON/OFF | 0-10V | DALI | TRIAC | CASAMBI.
220-240V 50/60Hz.

Accessories

N/A

Applications

An innovative solution for high performance, uniform illumination with optimal visual comfort. The miniature light heads and optics create a high definition, glare-controlled, circular light emission.
Application areas: residential, hotels, restaurants, retail, corridors.

Optional

Trimless

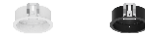

Trimles



Matte White



Matte Black



Matte Gold



Matte Copper



Matte Silver



Kingdom

Fixed Recessed

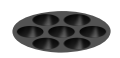
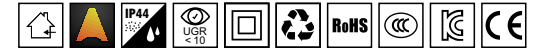

Kingdom
Fixed Round Trim Ø70mm

Kingdom
Fixed Round Trimless Ø120mm

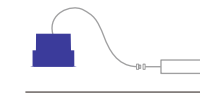
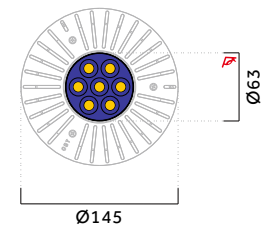
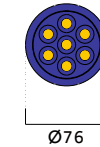
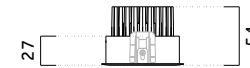

Code ordering example: * * . 7 0 5 4 . * * * * * *

	Product code	LED Power	Nominal Lumen	Finish	Cup	Beam Angle (BA°)	CCT Options	Dimming Options
Kingdom Fixed	01 Trim	Max.10.5W	1050lm	W White	W White	24 24°	27 2700K	0 ON/OFF
	30 Trimless			B Black	B Black	36 36°	30 3000K	1 0-10V
					G Gold		35 3500K	D DAIL
					C Copper		40 4000K	T TRIAC
					S Silver		TW 2700K-6500K	C CASAMBI

Kingdom

Fixed Recessed

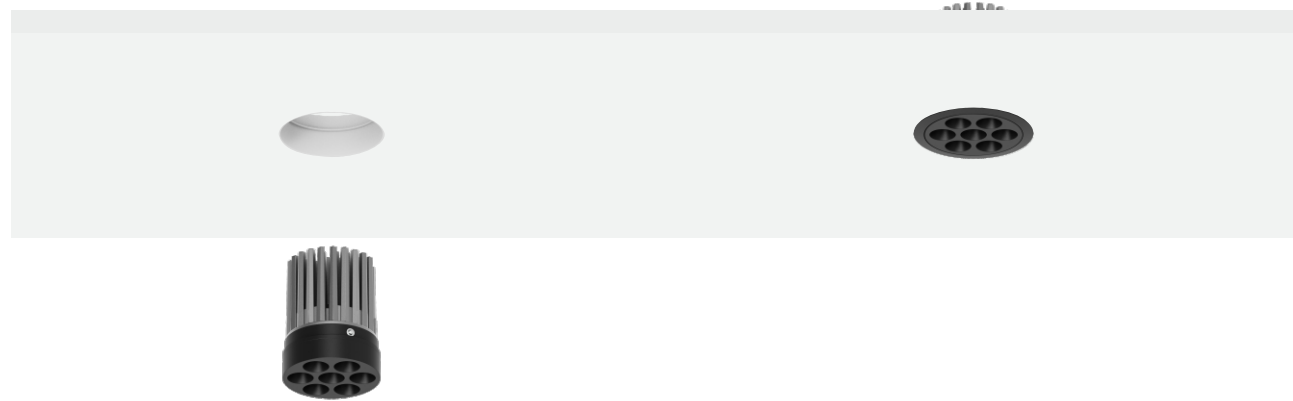

Body

Kingdom represents a breakthrough in architectural lighting. Its ultra-compact design enables versatile installation across various ceiling types, including shallow false ceilings where traditional solutions are not suitable.

Offering a range of refined finishes, including premium metallic options, these luminaires serve as both lighting sources and decorative elements, bringing an elegant, distinctive design touch to any space.

Optic

Reflector.
Beam Angle: 24° / 36°.

LED Sources

Light source options: High-power LED or COB LED.
CRI: 95 or 97 | CCT: 2700K / 3000K / 3500K / 4000K / 2700K-6500K (tunable white).
Additional CRI and CCT options available upon request.

Finish

Powder coated finish in white (W), black (B).

Driver

Supplied with non-dimmable remote driver.
Driver unit exceeds luminaire aperture; install above ceiling using extension cable.
Dimming Options: ON/OFF | 0-10V | DALI | TRIAC | CASAMBI.
220-240V 50/60Hz.

Accessories

N/A

Applications

An innovative solution for high performance, uniform illumination with optimal visual comfort. The miniature light heads and optics create a high definition, glare-controlled, circular light emission.
Application areas: residential, hotels, restaurants, retail, corridors.

Optional

Trimless

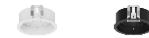

Trimles



Matte White



Matte Black



Matte Gold



Matte Copper



Matte Silver



Kingdom

Fixed Recessed

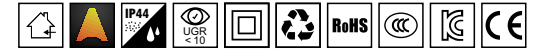

Kingdom
Fixed Round Trim Ø70mm

Kingdom
Fixed Round Trimless Ø120mm

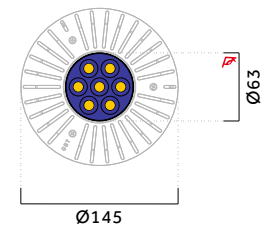
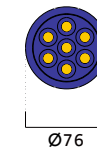
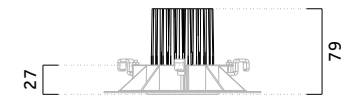
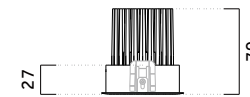

Code ordering example: * * . 7 0 7 9 . * * * * * *

	Product code	LED Power	Nominal Lumen	Finish	Cup	Beam Angle (BA°)	CCT Options	Dimming Options
Kingdom Fixed	01 Trim	Max.14W	1400lm	W White	W White	24 24°	27 2700K	0 ON/OFF
	30 Trimless			B Black	B Black	36 36°	30 3000K	1 0-10V
					G Gold		35 3500K	D DAIL
					C Copper		40 4000K	T TRIAC
					S Silver		TW 2700K-6500K	C CASAMBI

OBT
DESIGN

THE NATURAL EVOLUTION FROM THE LIGHT
SHADOW DOTS. THEY OFFER EXTREMELY
HIGH EFFECTIVENESS DESPITE THEIR SMALL
SIZE AND COMPACT BODY.

OBT
DESIGN

2019-01-20



Cabin S

Adjustable Recessed

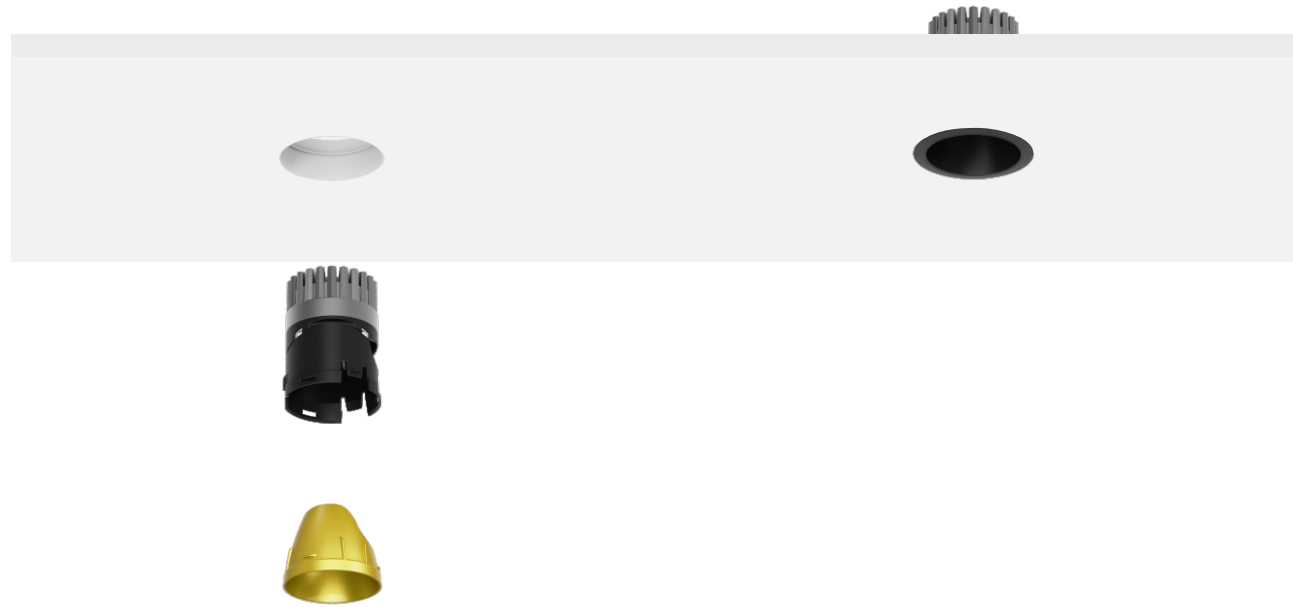

Body

Round cast aluminum mounting trim with spring-loaded clips for trim installation, or brackets for trimless installation. Suitable for ceiling thicknesses of 1–24 mm.

Luminaire body inclusive of snoot in cast aluminum.

Easy relamping via removable front ring with snap-in catch mechanism.

Available in two sizes with cut diameters of 70mm and 120mm.

Tiltable in directions up to 35°.

Optic

Lens.
Beam Angle: 13° / 24° / 38° / 50°.

LED Sources

Light source options: High-power LED or COB LED.
CRI: 95 or 97 | CCT: 2700K / 3000K / 3500K / 4000K.
Additional CRI and CCT options available upon request.

Finish

Powder coated finish in matt white (W), matt black (B), matt gold (G), matt copper (C), matt silver (S).

Driver

Supplied with non-dimmable remote driver.
Driver unit exceeds luminaire aperture; install above ceiling using extension cable.
Dimming Options: ON/OFF | 0-10V | DALI | TRIAC | CASAMBI.
220-240V 50/60Hz.

Accessories

N/A

Applications

The concealed light source ensures high visual comfort and allows the luminaire to blend seamlessly into its architectural environment, with the added flexibility of adjustable light aiming.

Optional

Trimless

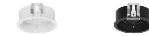

Trimles



Matte White



Matte Black



Matte Gold



Matte Copper



Matte Silver



Cabin S

Adjustable Recessed

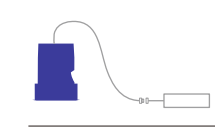
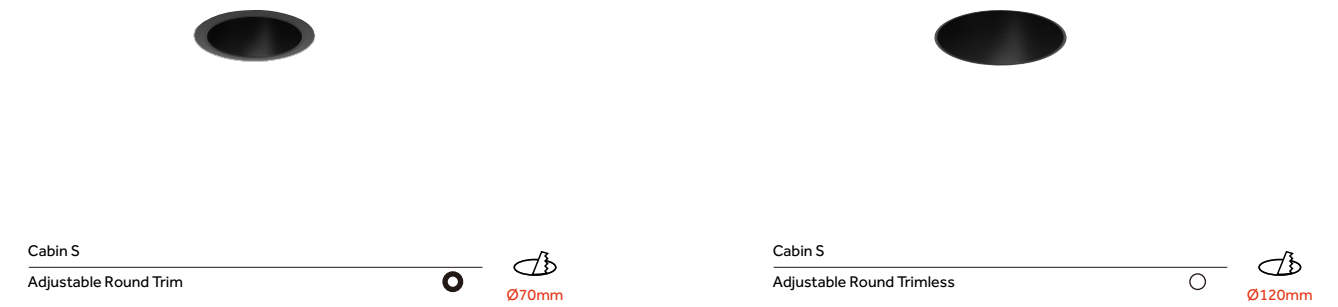
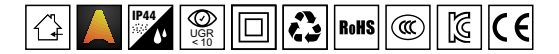

Code ordering example: * * . 7 0 9 5 . * * * * * *

	Product code	LED Power	Nominal Lumen	Finish	Cup	Beam Angle (BA°)	CCT Options	Dimming Options
Cabin Round Adjustable	02 Trim	Max.12W	1020lm	W White	W White	13 13°	27 2700K	0 ON/OFF
	11 Trimless			B Black	B Black	24 24°	30 3000K	1 0-10V
					G Gold	38 38°	35 3500K	D DAIL
					C Copper	50 50°	40 4000K	T TRIAC
					S Silver			C CASAMBI

Cabin S

Adjustable Recessed



Body

Round cast aluminum mounting trim with spring-loaded clips for trim installation, or brackets for trimless installation. Suitable for ceiling thicknesses of 1–24 mm.

Luminaire body inclusive of snoot in cast aluminum.

Easy relamping via removable front ring with snap-in catch mechanism.

Available in two sizes with cut diameters of 70mm and 120mm.

Tiltable in directions up to 35°.

Optic

Lens.
Beam Angle: 13° / 24° / 38° / 50°.

LED Sources

Light source options: High-power LED or COB LED.
CRI: 95 or 97 | CCT: 2700K / 3000K / 3500K / 4000K.
Additional CRI and CCT options available upon request.

Finish

Powder coated finish in matt white (W), matt black (B), matt gold (G), matt copper (C), matt silver (S).

Driver

Supplied with non-dimmable remote driver.
Driver unit exceeds luminaire aperture; install above ceiling using extension cable.
Dimming Options: ON/OFF | 0-10V | DALI | TRIAC | CASAMBI.
220-240V 50/60Hz.

Accessories

N/A

Applications

The concealed light source ensures high visual comfort and allows the luminaire to blend seamlessly into its architectural environment, with the added flexibility of adjustable light aiming.

Optional

Trimless

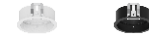

Trimles



Matte White



Matte Black



Matte Gold



Matte Copper



Matte Silver



Cabin S

Adjustable Recessed

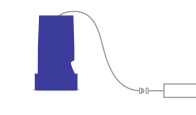
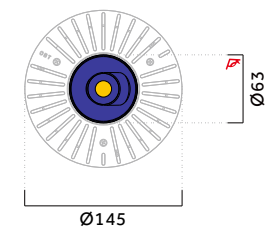
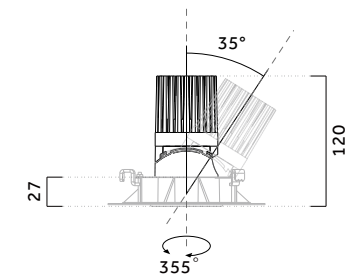
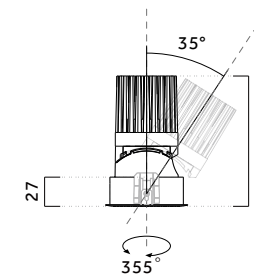
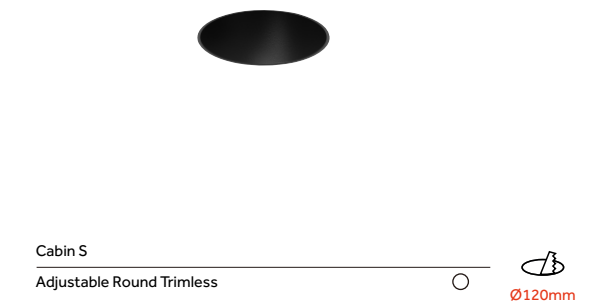
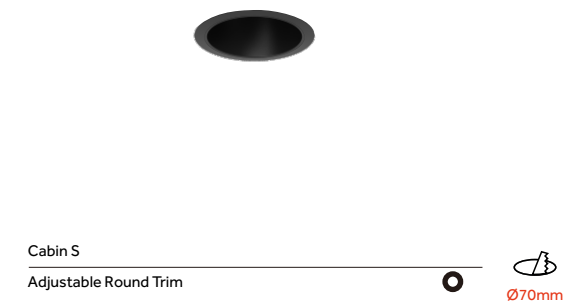
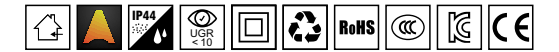

Code ordering example: * * . 7 0 2 0 . * * * * * *

	Product code	LED Power	Nominal Lumen	Finish	Cup	Beam Angle (BA°)	CCT Options	Dimming Options
Cabin Round Adjustable	02 Trim	Max.15W	1275lm	W White	W White	13 13°	27 2700K	0 ON/OFF
	11 Trimless			B Black	B Black	24 24°	30 3000K	1 0-10V
					G Gold	38 38°	35 3500K	D DAIL
					C Copper	50 50°	40 4000K	T TRIAC
					S Silver			C CASAMBI

Cabin S

Adjustable Recessed

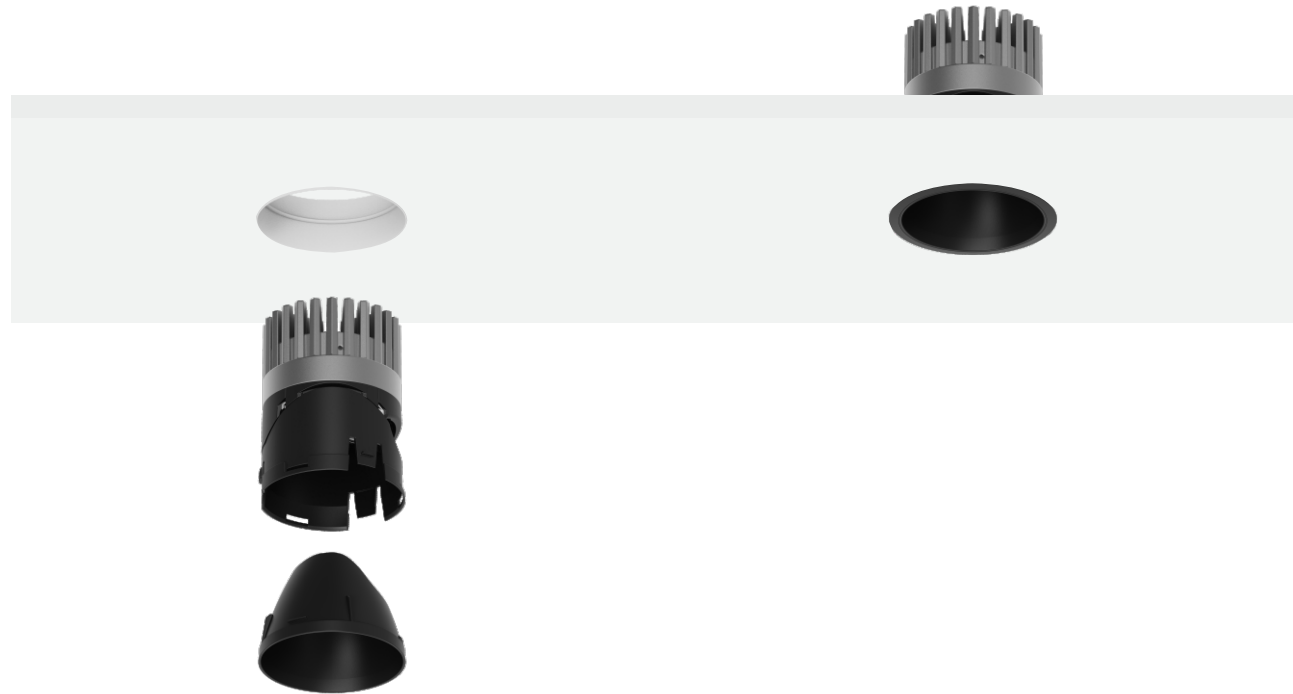

Body

Round cast aluminum mounting trim with spring-loaded clips for trim installation, or brackets for trimless installation. Suitable for ceiling thicknesses of 1–24 mm.

Luminaire body inclusive of snoot in cast aluminum.

Easy relamping via removable front ring with snap-in catch mechanism.

Available in two sizes with cut diameters of 70mm and 120mm.

Tilttable in directions up to 35°.

Optic

Lens.
Beam Angle: 13° / 24° / 36° / 50°.

LED Sources

Light source options: High-power LED or COB LED.
CRI: 95 or 97 | CCT: 2700K / 3000K / 3500K / 4000K.
Additional CRI and CCT options available upon request.

Finish

Powder coated finish in matt white (W), matt black (B), matt gold (G), matt copper (C), matt silver (S).

Driver

Supplied with non-dimmable remote driver.
Driver unit exceeds luminaire aperture; install above ceiling using extension cable.
Dimming Options: ON/OFF | 0-10V | DALI | TRIAC | CASAMBI.
220-240V 50/60Hz.

Accessories

N/A

Applications

The concealed light source ensures high visual comfort and allows the luminaire to blend seamlessly into its architectural environment, with the added flexibility of adjustable light aiming.

Optional

- Trimless
- Trimles
- Matte White
- Matte Black
- Matte Gold
- Matte Copper
- Matte Silver

Cabin S

Adjustable Recessed

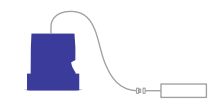
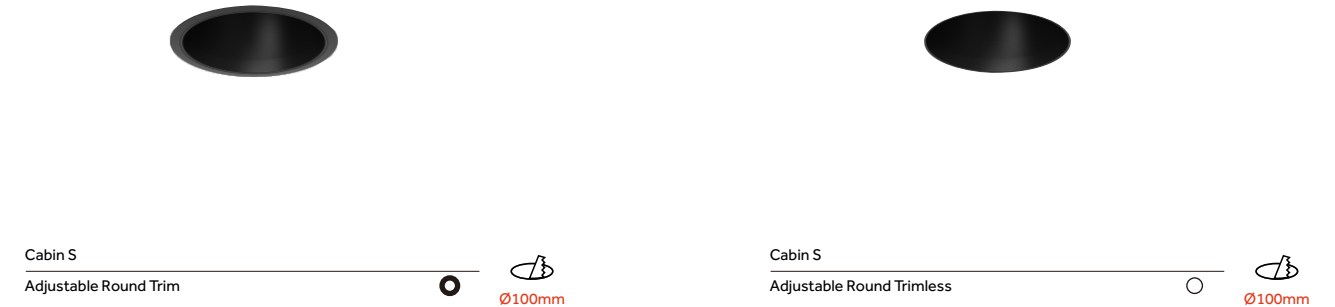
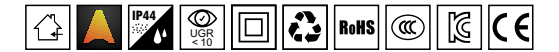

Code ordering example: * * . 1 0 3 0 . * * * * * *

	Product code	LED Power	Nominal Lumen	Finish	Cup	Beam Angle (BA°)	CCT Options	Dimming Options
Cabin S Round Adjustable	02 Trim	Max.20W	1700lm	W White	W White	15 15°	27 2700K	0 ON/OFF
	11 Trimless			B Black	B Black	24 24°	30 3000K	1 0-10V
					G Gold	36 36°	35 3500K	D DAIL
					C Copper	50 50°	40 4000K	T TRIAC
					S Silver			C CASAMBI

Cabin S

Adjustable Recessed

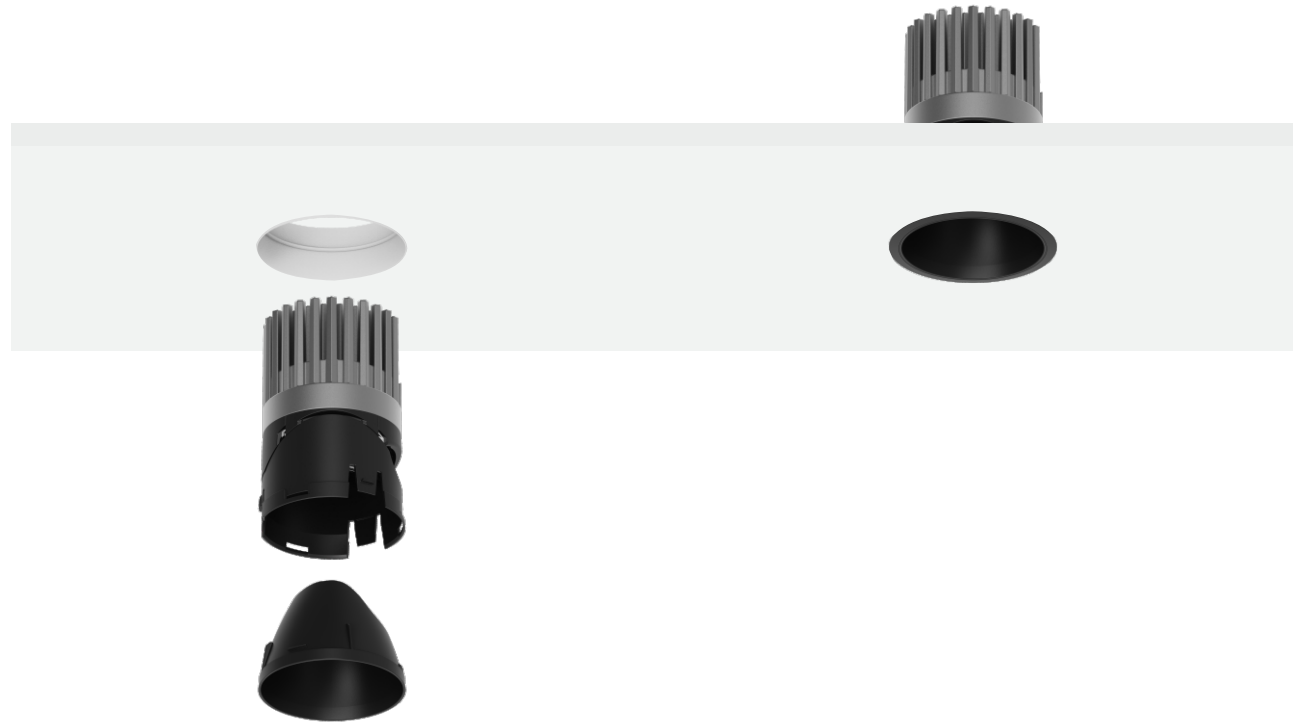

Body

Round cast aluminum mounting trim with spring-loaded clips for trim installation, or brackets for trimless installation. Suitable for ceiling thicknesses of 1–24 mm.

Luminaire body inclusive of snoot in cast aluminum.

Easy relamping via removable front ring with snap-in catch mechanism.

Available in two sizes with cut diameters of 70mm and 120mm.

Tiltable in directions up to 35°.

Optic

Lens.
Beam Angle: 13° / 24° / 36° / 50°.

LED Sources

Light source options: High-power LED or COB LED.
CRI: 95 or 97 | CCT: 2700K / 3000K / 3500K / 4000K.
Additional CRI and CCT options available upon request.

Finish

Powder coated finish in matt white (W), matt black (B), matt gold (G), matt copper (C), matt silver (S).

Driver

Supplied with non-dimmable remote driver.
Driver unit exceeds luminaire aperture; install above ceiling using extension cable.
Dimming Options: ON/OFF | 0-10V | DALI | TRIAC | CASAMBI.
220-240V 50/60Hz.

Accessories

N/A

Applications

The concealed light source ensures high visual comfort and allows the luminaire to blend seamlessly into its architectural environment, with the added flexibility of adjustable light aiming.

Optional

- Trimless
- Trimles
- Matte White
- Matte Black
- Matte Gold
- Matte Copper
- Matte Silver

Cabin S

Adjustable Recessed

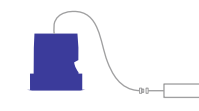
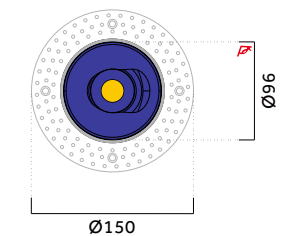
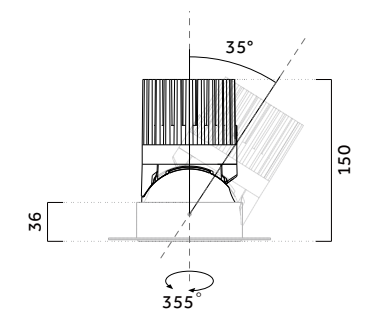
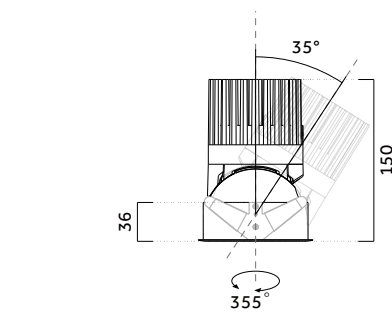
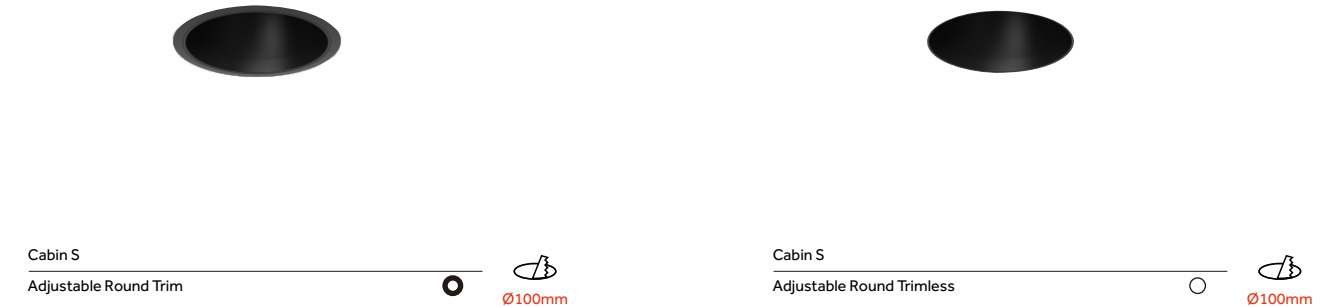
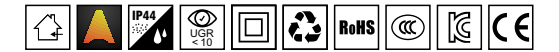

Code ordering example: * * . 1 0 5 0 . * * * * * *

	Product code	LED Power	Nominal Lumen	Finish	Cup	Beam Angle (BA°)	CCT Options	Dimming Options
Cabin S Round Adjustable	02 Trim	Max.30W	2550lm	W White	W White	15 15°	27 2700K	0 ON/OFF
	11 Trimless			B Black	B Black	24 24°	30 3000K	1 0-10V
					G Gold	36 36°	35 3500K	D DAIL
					C Copper	50 50°	40 4000K	T TRIAC
					S Silver			C CASAMBI

Cabin D

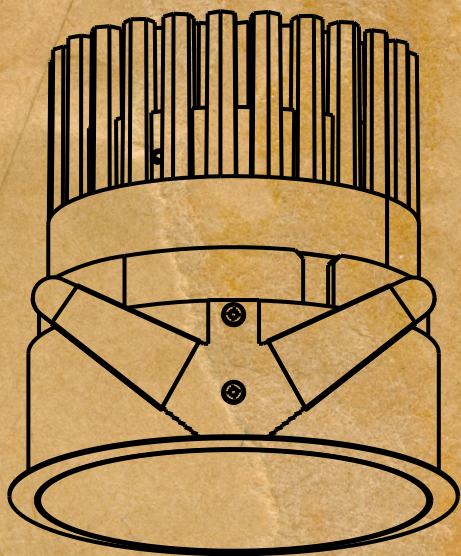

Light Up Life

Cabini D



Cabin D

Fixed Recessed

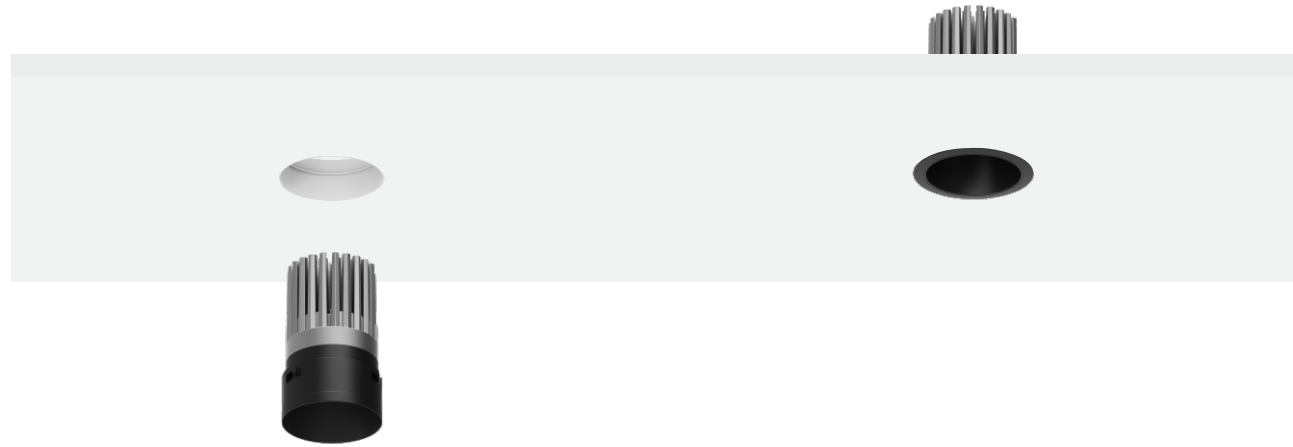

Body

The Cabin D downlight series comprises recessed fixtures characterized by essential forms, extensive range depth, excellent performance, and high efficiency. This comprehensive product line is particularly suited for commercial and retail environments where reliability, efficiency, and light quality are paramount.

The trim version features a visible stop ring with black or white finish options (depending on size). The ultra-thin ring is integrated into the fixture for seamless architectural integration.

Optic

Lens.
Beam Angle: 15° / 24° / 36° / 50°.

LED Sources

Light source options: High-power LED or COB LED.
CRI: 95 or 97 | CCT: 2700K / 3000K / 3500K / 4000K / 2700K-6500K (tunable white).
Additional CRI and CCT options available upon request.

Finish

Powder coated finish in matt white (W), matt black (B), matt gold (G), matt copper (C), matt silver (S).

Driver

Supplied with non-dimmable remote driver.
Driver unit exceeds luminaire aperture; install above ceiling using extension cable.
Dimming Options: ON/OFF | 0-10V | DALI | TRIAC | CASAMBI.
220-240V 50/60Hz.

Accessories

N/A

Applications

Its concealed light source for high visual comfort ensures this luminaire blends seamlessly into its architectural environment. With the added flexibility of light aiming.
Application areas: Corridors, retail, showrooms, residential, restaurants, hotels.

Optional

Trimless



Trimles



Cabin D Fixed Recessed

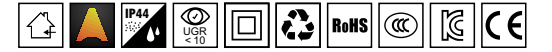

Cabin D
Fixed Round Trim Ø70mm

Cabin D
Fixed Round Trimless Ø70mm

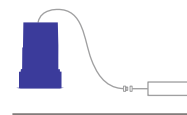
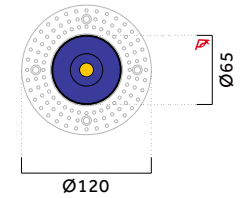
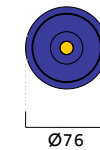
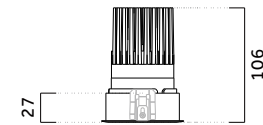

Code ordering example: * * . 7 0 0 6 . * * * * * *

	Product code	LED Power	Nominal Lumen	Finish	Cup	Beam Angle (BA°)	CCT Options	Dimming Options
Cabin D Round Fixed	01 Trim	Max.16W	1600lm	W White	W White	15 15°	27 2700K	0 ON/OFF
	30 Trimless			B Black	B Black	24 24°	30 3000K	1 0-10V
					G Gold	36 36°	35 3500K	D DAIL
					C Copper	50 50°	40 4000K	T TRIAC
					S Silver		TW 2700K-6500K	C CASAMBI

Cabin D

Fixed Recessed

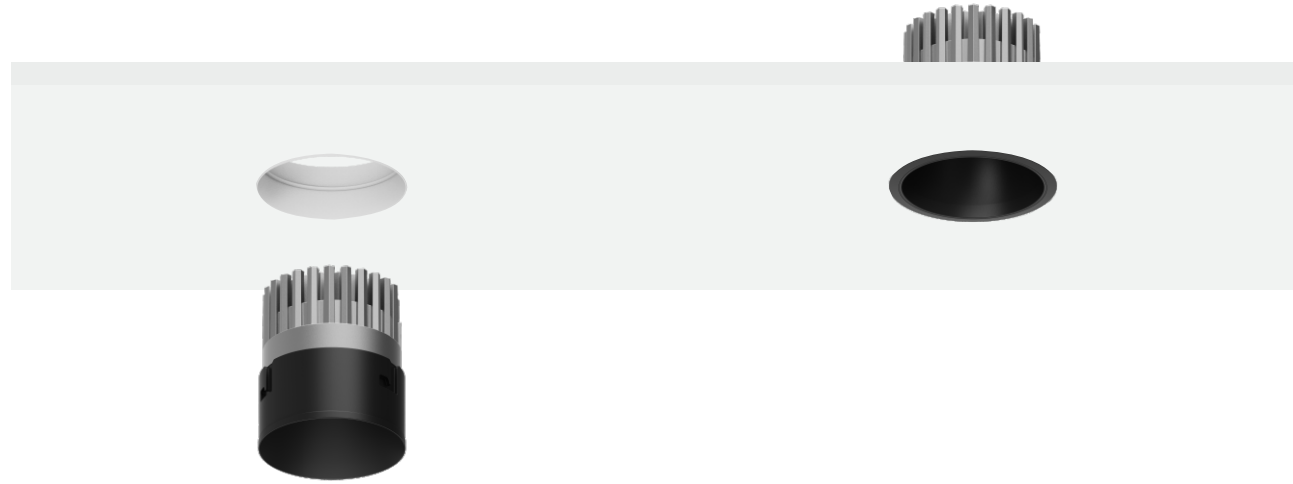

Body

The Cabin D downlight series comprises recessed fixtures characterized by essential forms, extensive range depth, excellent performance, and high efficiency. This comprehensive product line is particularly suited for commercial and retail environments where reliability, efficiency, and light quality are paramount.

The trim version features a visible stop ring with black or white finish options (depending on size). The ultra-thin ring is integrated into the fixture for seamless architectural integration.

Optic

Lens.
Beam Angle: 15° / 24° / 36° / 50°.

LED Sources

Light source options: High-power LED or COB LED.
CRI: 95 or 97 | CCT: 2700K / 3000K / 3500K / 4000K / 2700K-6500K (tunable white).
Additional CRI and CCT options available upon request.

Finish

Powder coated finish in matt white (W), matt black (B), matt gold (G), matt copper (C), matt silver (S).

Driver

Supplied with non-dimmable remote driver.
Driver unit exceeds luminaire aperture; install above ceiling using extension cable.
Dimming Options: ON/OFF | 0-10V | DALI | TRIAC | CASAMBI.
220-240V 50/60Hz.

Accessories

N/A

Applications

Its concealed light source for high visual comfort ensures this luminaire blends seamlessly into its architectural environment. With the added flexibility of light aiming.
Application areas: Corridors, retail, showrooms, residential, restaurants, hotels.

Optional

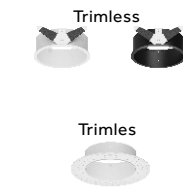

Cabin D

Fixed Recessed

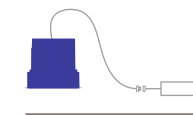
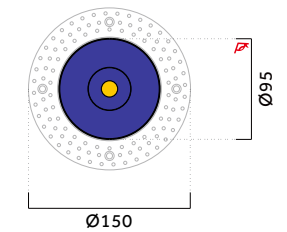
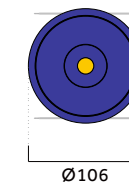
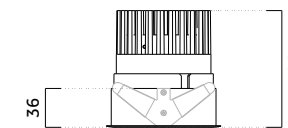
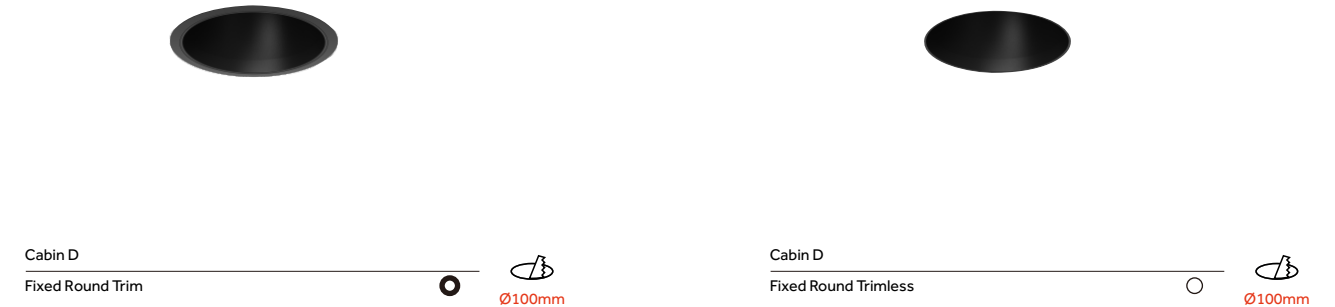
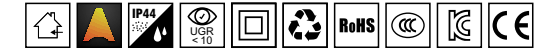

Code ordering example: * * . 1 0 0 8 . * * * * * *

	Product code	LED Power	Nominal Lumen	Finish	Cup	Beam Angle (BA°)	CCT Options	Dimming Options
Cabin D Round Fixed	01 Trim	Max.20W	2000lm	W White	W White	15 15°	27 2700K	0 ON/OFF
	30 Trimless			B Black	B Black	24 24°	30 3000K	1 0-10V
					G Gold	36 36°	35 3500K	D DAIL
					C Copper	50 50°	40 4000K	T TRIAC
					S Silver		TW 2700K-6500K	C CASAMBI

Cabin D

Fixed Recessed

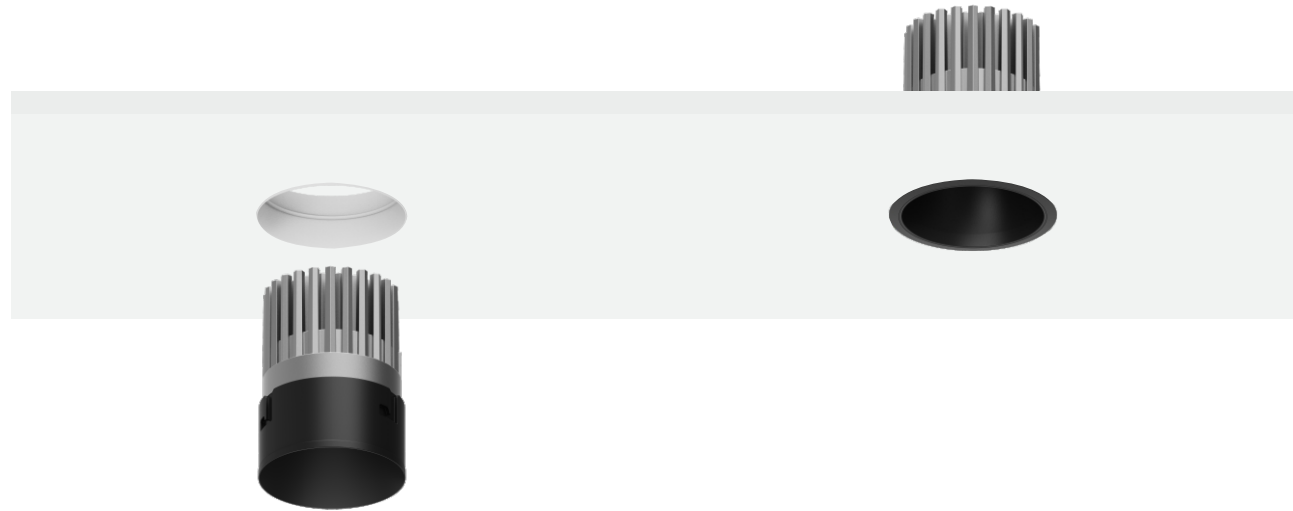

Body

The Cabin D downlight series comprises recessed fixtures characterized by essential forms, extensive range depth, excellent performance, and high efficiency. This comprehensive product line is particularly suited for commercial and retail environments where reliability, efficiency, and light quality are paramount.

The trim version features a visible stop ring with black or white finish options (depending on size). The ultra-thin ring is integrated into the fixture for seamless architectural integration.

Optic

Lens.
Beam Angle: 15° / 24° / 36° / 50°.

LED Sources

Light source options: High-power LED or COB LED.
CRI: 95 or 97 | CCT: 2700K / 3000K / 3500K / 4000K / 2700K-6500K (tunable white).
Additional CRI and CCT options available upon request.

Finish

Powder coated finish in matt white (W), matt black (B), matt gold (G), matt copper (C), matt silver (S).

Driver

Supplied with non-dimmable remote driver.
Driver unit exceeds luminaire aperture; install above ceiling using extension cable.
Dimming Options: ON/OFF | 0-10V | DALI | TRIAC | CASAMBI.
220-240V 50/60Hz.

Accessories

N/A

Applications

Its concealed light source for high visual comfort ensures this luminaire blends seamlessly into its architectural environment. With the added flexibility of light aiming.
Application areas: Corridors, retail, showrooms, residential, restaurants, hotels.

Optional

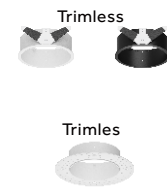

Cabin D Fixed Recessed

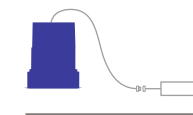
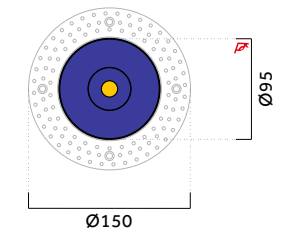
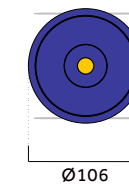
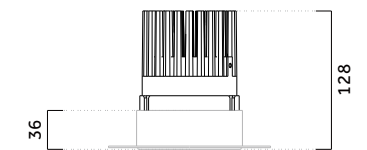
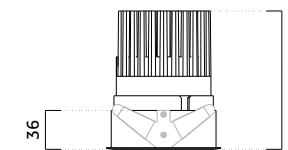
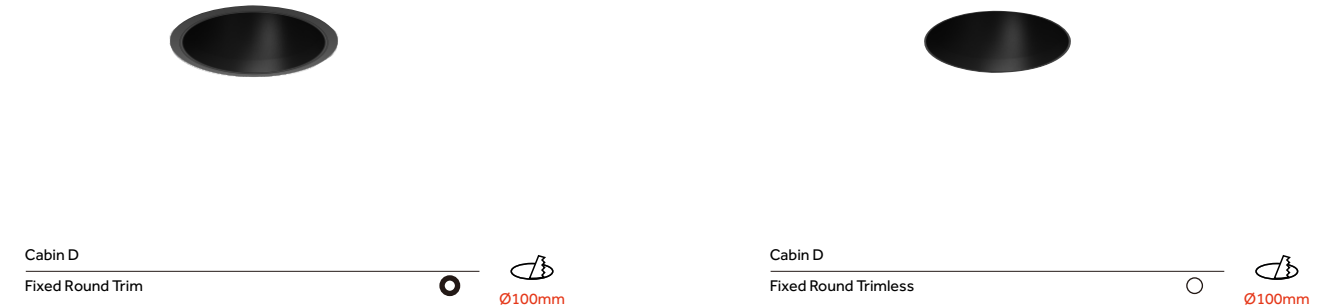

Code ordering example: * * . 1 0 2 8 . * * * * * *

	Product code	LED Power	Nominal Lumen	Finish	Cup	Beam Angle (BA°)	CCT Options	Dimming Options
Cabin D Round Fixed	01 Trim	Max.30W	3000lm	W White	W White	15 15°	27 2700K	0 ON/OFF
	30 Trimless			B Black	B Black	24 24°	30 3000K	1 0-10V
					G Gold	36 36°	35 3500K	D DAIL
					C Copper	50 50°	40 4000K	T TRIAC
					S Silver		TW 2700K-6500K	C CASAMBI

Reflector
Cabin R

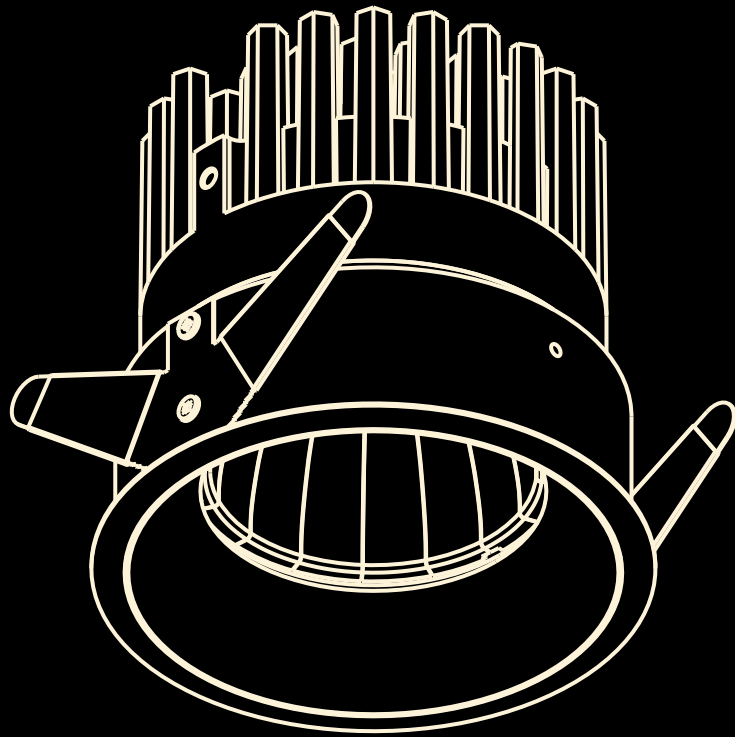

TO PROVIDE A **COMFORTABLE**
SPACE FOR YOU WHO HAVE BEEN
BUSY WITH GREEN WORK ALL DAY

CabinR



Cabin R

Fixed Recessed

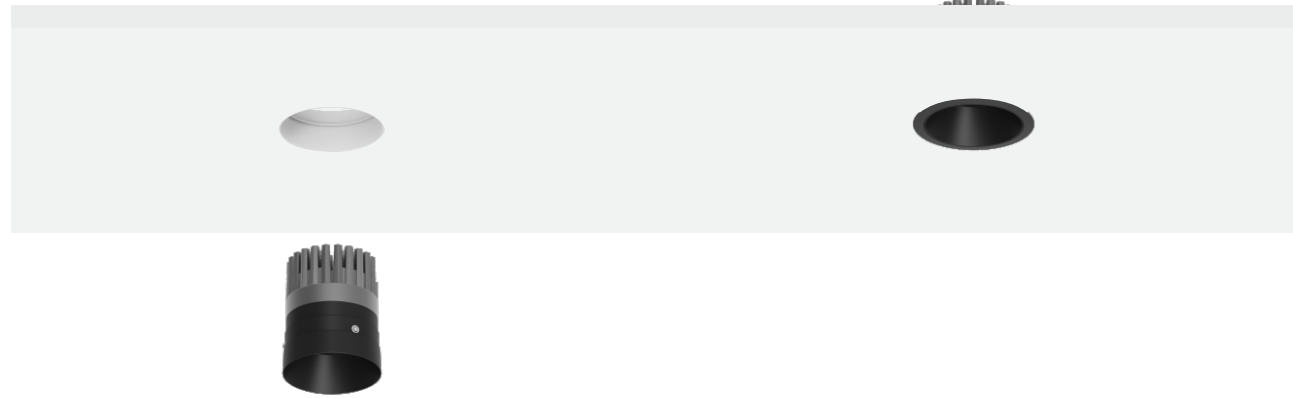

Body

The Cabin R features a fixed circular design with a visually simple, seamless form that ensures excellent visual comfort. The versatile reflector cup version maintains a uniform appearance across all configurations.

Available in decorative and non-decorative versions with diameters of Ø70 mm, Ø120 mm, and Ø150 mm. The main body is constructed from lightweight die-cast aluminum.

Optic

Reflector.
Beam Angle: 28° / 38° / 55°.

LED Sources

Light source options: High-power LED or COB LED.
CRI: 95 or 97 | CCT: 2700K / 3000K / 3500K / 4000K.
Additional CRI and CCT options available upon request.

Finish

Powder coated finish in matt white (W), matt black (B), matt gold (G), matt copper (C), matt silver (S).

Driver

Supplied with non-dimmable remote driver.
Driver unit exceeds luminaire aperture; install above ceiling using extension cable.
Dimming Options: ON/OFF | 0-10V | DALI | TRIAC | CASAMBI.
220-240V 50/60Hz.

Accessories

N/A

Applications

Its concealed light source for high visual comfort ensures this luminaire blends seamlessly into its architectural environment. With the added flexibility of light aiming.
Application areas: Corridors, retail, showrooms, residential, restaurants, hotels.

Optional

Trimless



Trimles



Cabin R Fixed Recessed

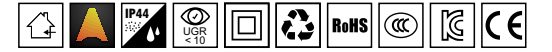

Cabin R
Fixed Round Trim Ø70mm

Cabin R
Fixed Round Trimless Ø120mm

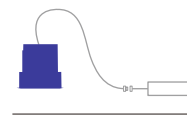
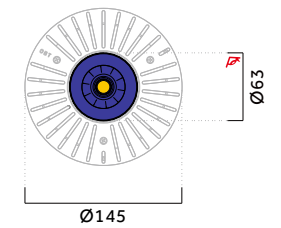
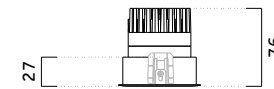

Code ordering example: * * . 7 0 7 6 . * * * * * *

	Product code	LED Power	Nominal Lumen	Finish	Cup	Beam Angle (BA°)	CCT Options	Dimming Options
Cabin R Round Fixed	01 Trim	Max.12W	1320lm	W White	W White	28 28°	27 2700K	0 ON/OFF
	30 Trimless			B Black	B Black	38 38°	30 3000K	1 0-10V
					G Gold	55 55°	35 3500K	D DAIL
					C Copper		40 4000K	T TRIAC
					S Silver			C CASAMBI

Cabin R

Fixed Recessed

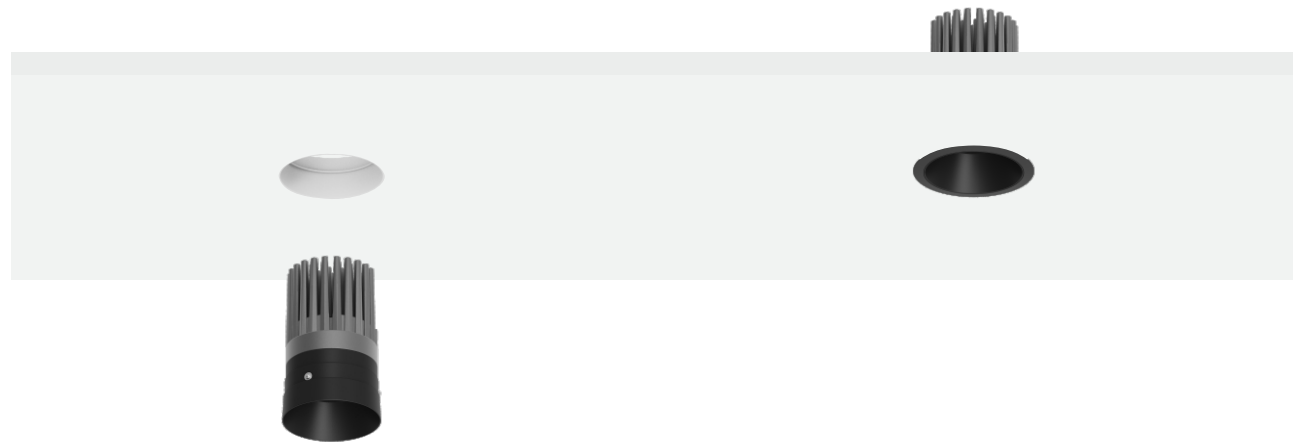

Body

The Cabin R features a fixed circular design with a visually simple, seamless form that ensures excellent visual comfort. The versatile reflector cup version maintains a uniform appearance across all configurations.

Available in decorative and non-decorative versions with diameters of Ø70 mm, Ø120 mm, and Ø150 mm. The main body is constructed from lightweight die-cast aluminum.

Finish

Powder coated finish in matt white (W), matt black (B), matt gold (G), matt copper (C), matt silver (S).

Optional

Trimless



Trimles



Driver

Supplied with non-dimmable remote driver. Driver unit exceeds luminaire aperture; install above ceiling using extension cable. Dimming Options: ON/OFF | 0-10V | DALI | TRIAC | CASAMBI. 220-240V 50/60Hz.

Accessories

N/A

Optic

Reflector.
Beam Angle: 28° / 38° / 55°.

LED Sources

Light source options: High-power LED or COB LED. CRI: 95 or 97 | CCT: 2700K / 3000K / 3500K / 4000K. Additional CRI and CCT options available upon request.

Applications

Its concealed light source for high visual comfort ensures this luminaire blends seamlessly into its architectural environment. With the added flexibility of light aiming. Application areas: Corridors, retail, showrooms, residential, restaurants, hotels.

Cabin R Fixed Recessed

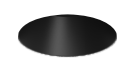
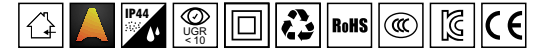

Cabin R
Fixed Round Trim Ø70mm

Cabin R
Fixed Round Trimless Ø120mm

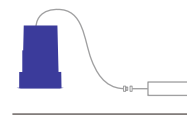
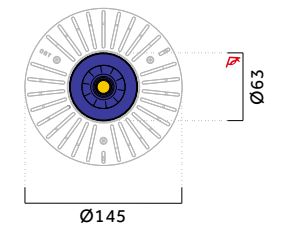
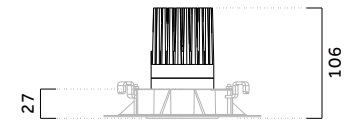
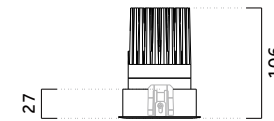

Code ordering example: * * . 7 0 0 5 . * * * * * *

	Product code	LED Power	Nominal Lumen	Finish	Cup	Beam Angle (BA°)	CCT Options	Dimming Options
Cabin R Round Fixed	01 Trim	Max.16W	1760lm	W White	W White	28 28°	27 2700K	0 ON/OFF
	30 Trimless			B Black	B Black	38 38°	30 3000K	1 0-10V
					G Gold	55 55°	35 3500K	D DAIL
					C Copper		40 4000K	T TRIAC
					S Silver			C CASAMBI

Cabin R

Fixed Recessed

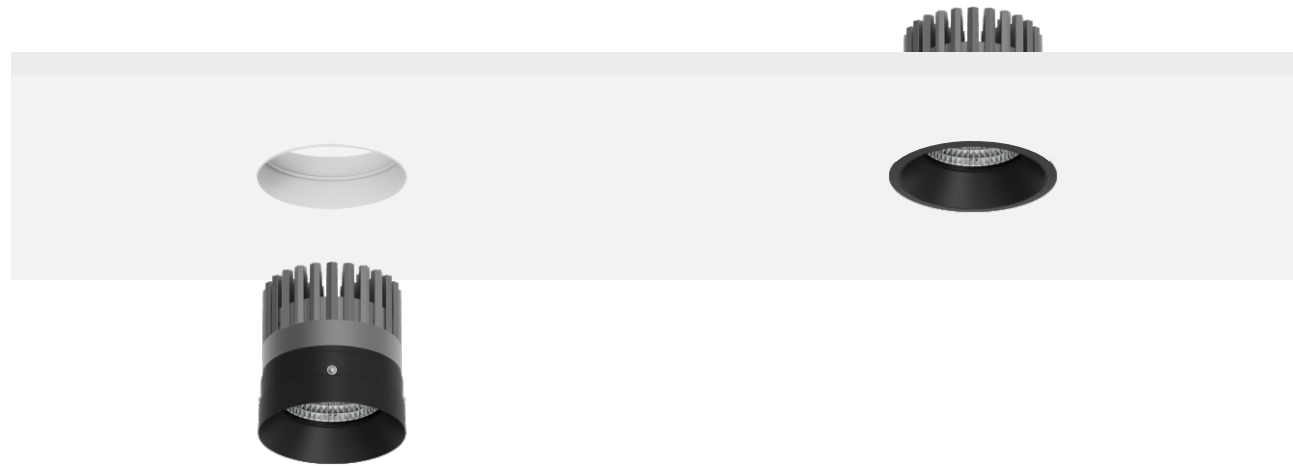

Body

The Cabin R features a fixed circular design with a visually simple, seamless form that ensures excellent visual comfort. The versatile reflector cup version maintains a uniform appearance across all configurations.

Available in decorative and non-decorative versions with diameters of Ø70 mm, Ø120 mm, and Ø150 mm. The main body is constructed from lightweight die-cast aluminum.

Finish

Powder coated finish in matt white (W), matt black (B), matt gold (G), matt copper (C), matt silver (S).

Optional

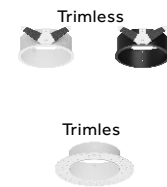

Driver

Supplied with non-dimmable remote driver. Driver unit exceeds luminaire aperture; install above ceiling using extension cable. Dimming Options: ON/OFF | 0-10V | DALI | TRIAC | CASAMBI. 220-240V 50/60Hz.

Accessories

N/A

Optic

Reflector.
Beam Angle: 28° / 38° / 55°.

LED Sources

Light source options: High-power LED or COB LED. CRI: 95 or 97 | CCT: 2700K / 3000K / 3500K / 4000K. Additional CRI and CCT options available upon request.

Applications

Its concealed light source for high visual comfort ensures this luminaire blends seamlessly into its architectural environment. With the added flexibility of light aiming. Application areas: Corridors, retail, showrooms, residential, restaurants, hotels.

Cabin R Fixed Recessed

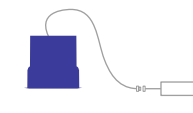
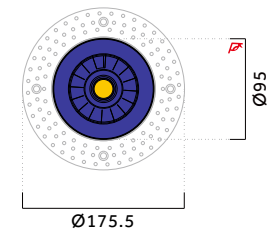
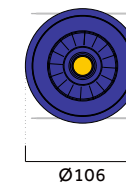
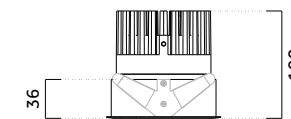
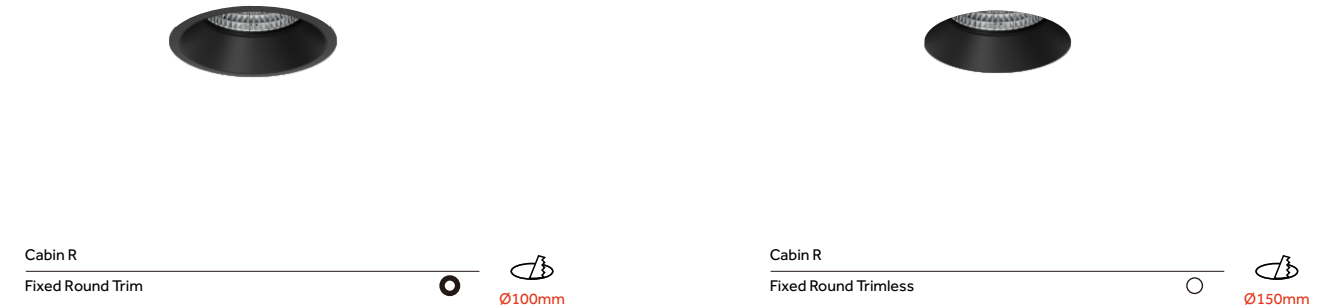
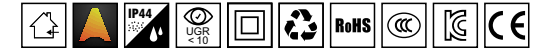

Code ordering example: * * . 1 0 0 0 . * * * * * *

	Product code	LED Power	Nominal Lumen	Finish	Cup	Beam Angle (BA°)	CCT Options	Dimming Options
Cabin R Round Fixed	01 Trim	Max.20W	2200lm	W White	W White	28 28°	27 2700K	0 ON/OFF
	30 Trimless			B Black	B Black	38 38°	30 3000K	1 0-10V
					G Gold	55 55°	35 3500K	D DAIL
					C Copper		40 4000K	T TRIAC
					S Silver			C CASAMBI

Cabin R

Fixed Recessed

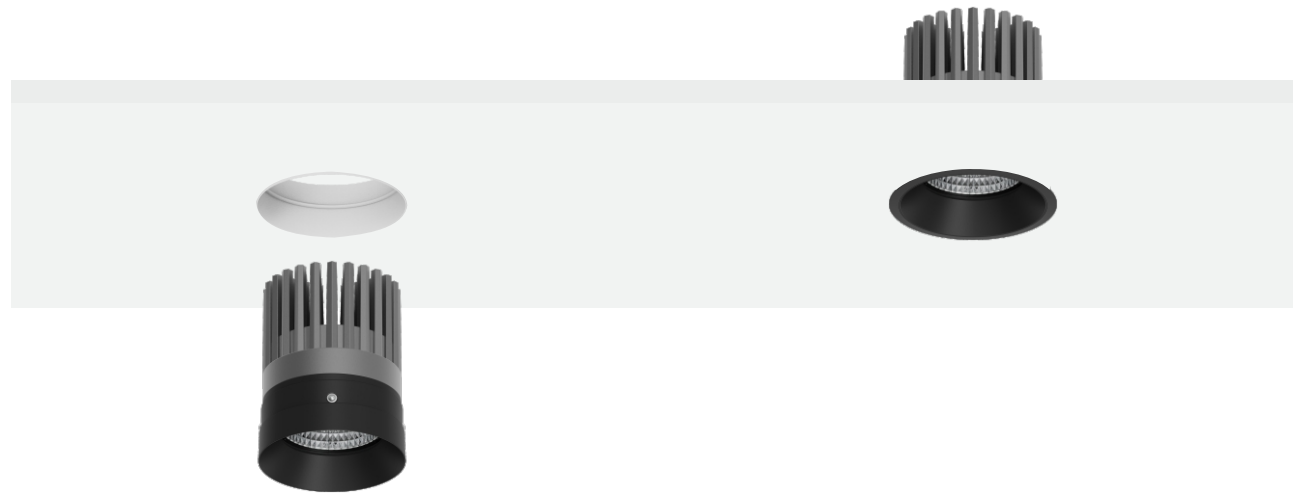

Body

The Cabin R features a fixed circular design with a visually simple, seamless form that ensures excellent visual comfort. The versatile reflector cup version maintains a uniform appearance across all configurations.

Available in decorative and non-decorative versions with diameters of Ø70 mm, Ø120 mm, and Ø150 mm. The main body is constructed from lightweight die-cast aluminum.

Finish

Powder coated finish in matt white (W), matt black (B), matt gold (G), matt copper (C), matt silver (S).

Optional

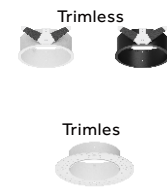

Driver

Supplied with non-dimmable remote driver. Driver unit exceeds luminaire aperture; install above ceiling using extension cable. Dimming Options: ON/OFF | 0-10V | DALI | TRIAC | CASAMBI. 220-240V 50/60Hz.

Accessories

N/A

Optic

Reflector.
Beam Angle: 28° / 38° / 55°.

LED Sources

Light source options: High-power LED or COB LED. CRI: 95 or 97 | CCT: 2700K / 3000K / 3500K / 4000K. Additional CRI and CCT options available upon request.

Applications

Its concealed light source for high visual comfort ensures this luminaire blends seamlessly into its architectural environment. With the added flexibility of light aiming. Application areas: Corridors, retail, showrooms, residential, restaurants, hotels.

Cabin R

Fixed Recessed

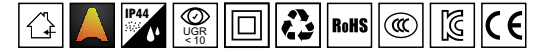

Cabin R
Fixed Round Trim Ø100mm

Cabin R
Fixed Round Trimless Ø150mm

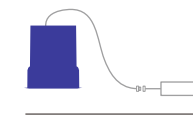
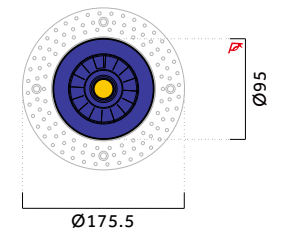
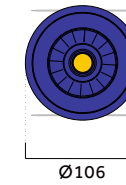
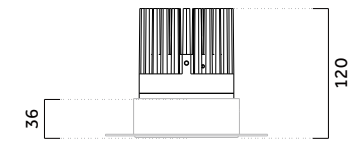
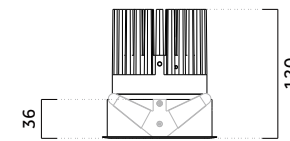

Code ordering example: * * . 1 0 2 0 . * * * * * *

	Product code	LED Power	Nominal Lumen	Finish	Cup	Beam Angle (BA°)	CCT Options	Dimming Options
Cabin R Round Fixed	01 Trim	Max.25W	2750lm	W White	W White	28 28°	27 2700K	0 ON/OFF
	30 Trimless			B Black	B Black	38 38°	30 3000K	1 0-10V
					G Gold	55 55°	35 3500K	D DAIL
					C Copper		40 4000K	T TRIAC
					S Silver			C CASAMBI

Cabin M

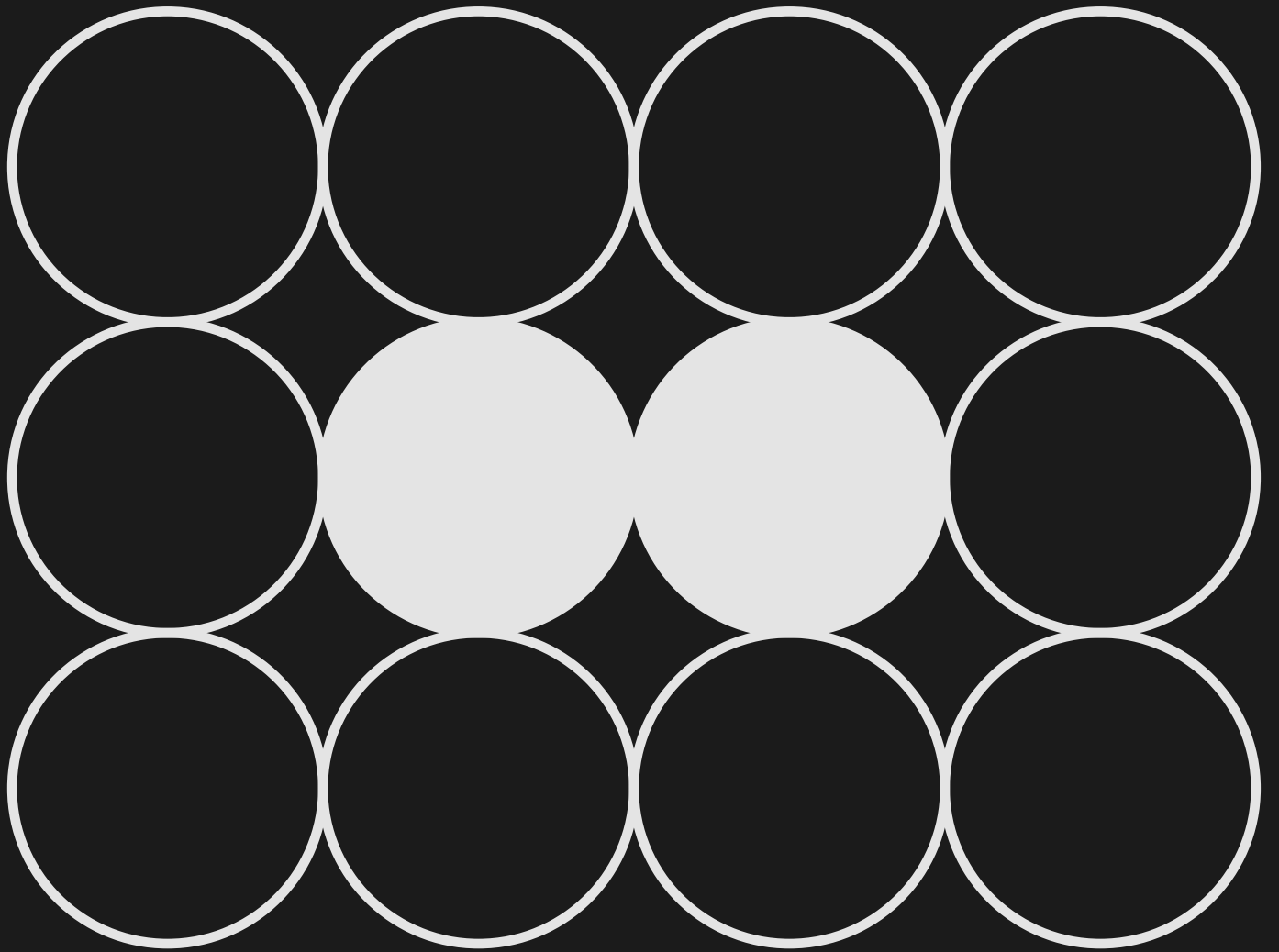

light

It's life's eyes

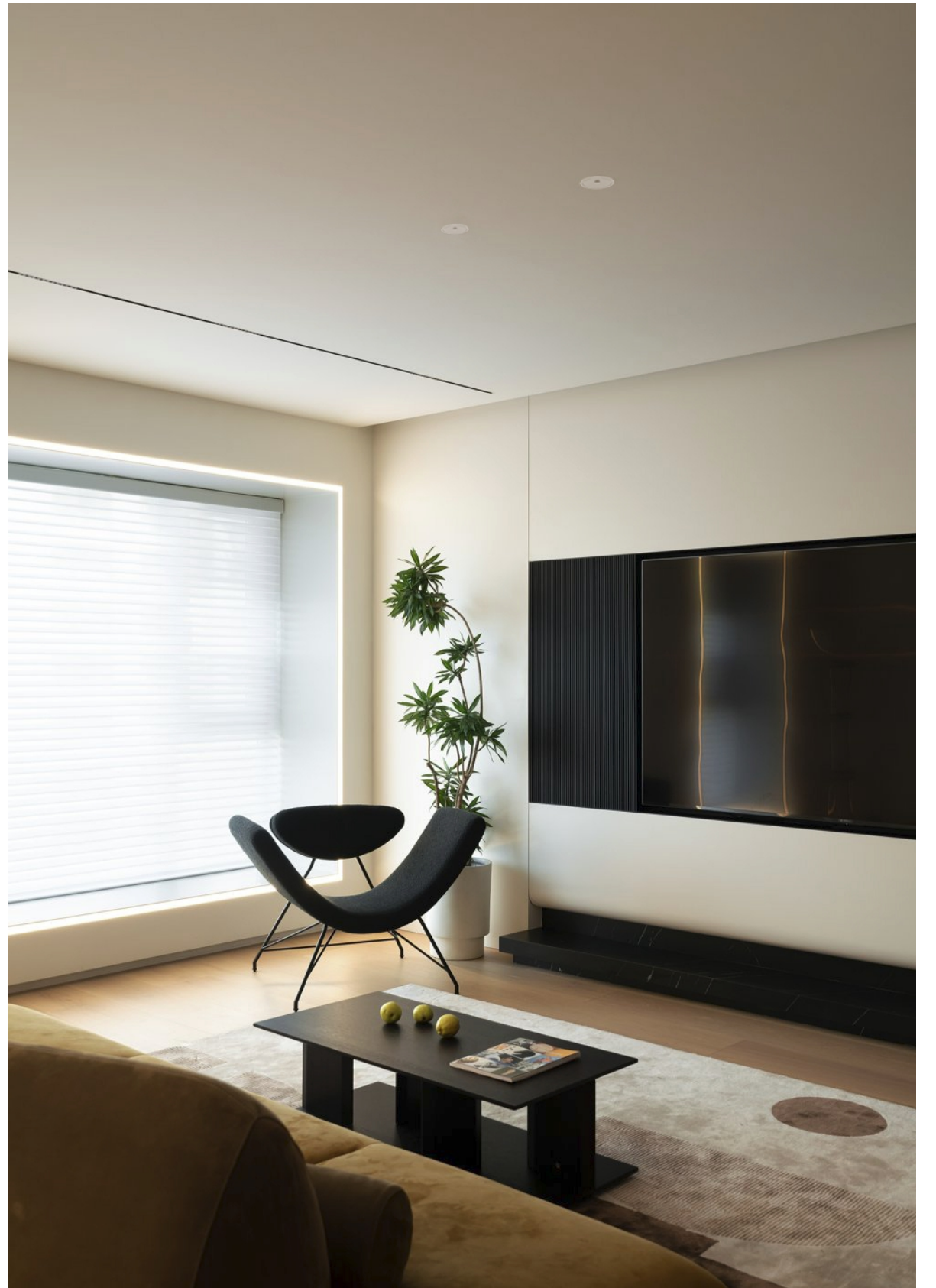

Cabin M

Fixed Recessed

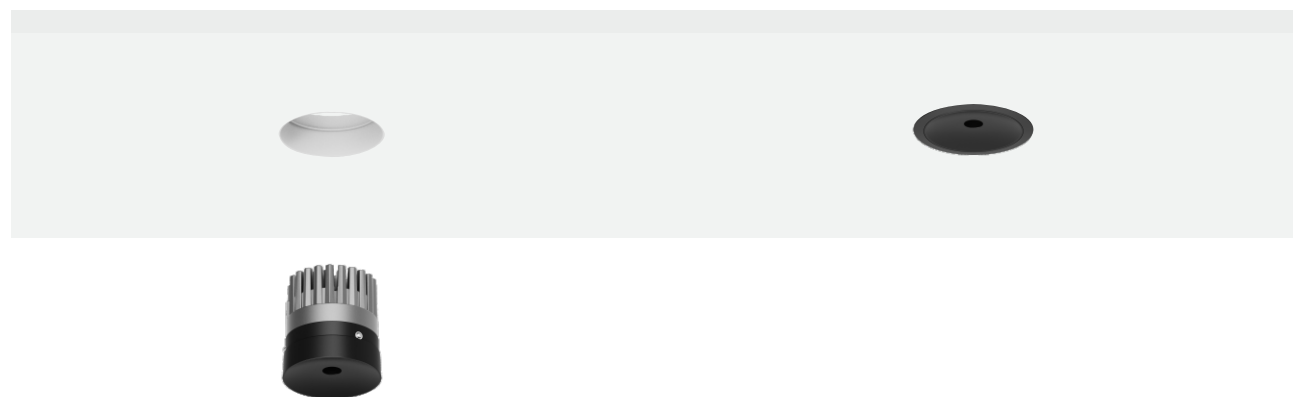

Body

The Cabin M is a recessed downlight featuring an ultra-compact Ø12 mm aperture, suitable for both trim and trimless installations.

It offers easy maintenance and is equipped with high-efficiency LEDs delivering excellent color rendering. This variant ensures broad compatibility with diverse ceiling types and finishes.

The internal trim can be discreetly concealed using matching ceiling materials, creating a seamless and uninterrupted ceiling aesthetic.

Optic

Lens.
Beam Angle: 24° / 36° / 50°.

LED Sources

Light source options: High-power LED or COB LED.
CRI: 95 or 97 | CCT: 2700K / 3000K / 3500K / 4000K.
Additional CRI and CCT options available upon request.

Finish

Powder coated finish in matt white (W), matt black (B).

Driver

Supplied with non-dimmable remote driver.
Driver unit exceeds luminaire aperture; install above ceiling using extension cable.
Dimming Options: ON/OFF | 0-10V | DALI | TRIAC | CASAMBI.
220-240V 50/60Hz.

Accessories

N/A

Applications

Its concealed light source for high visual comfort ensures this luminaire blends seamlessly into its architectural environment. With the added flexibility of light aiming.
Application areas: Corridors, retail, showrooms, residential, restaurants, hotels.

Optional

Trimless

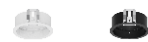

Trimless



Cabin M

Fixed Recessed



Cabin M
Fixed Round Trim Ø70mm

Cabin M
Fixed Round Trimless Ø120mm

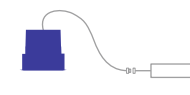
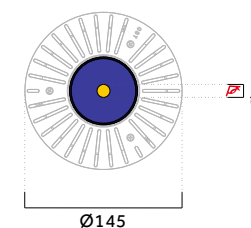
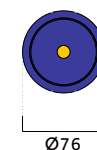
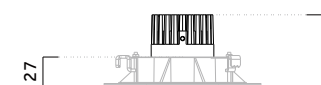
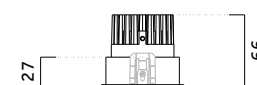

Code ordering example: . .

	Product code	LED Power	Nominal Lumen	Finish	Cup	Beam Angle (BA°)	CCT Options	Dimming Options
Cabin D Round Fixed	01 Trim	Max.12W	720lm	W White	W White	24 24°	27 2700K	0 ON/OFF
	30 Trimless			B Black	B Black	36 36°	30 3000K	1 0-10V
						50 50°	35 3500K	D DAIL
						40 4000K		T TRIAC
								C CASAMBI

Cabin M

Fixed Recessed

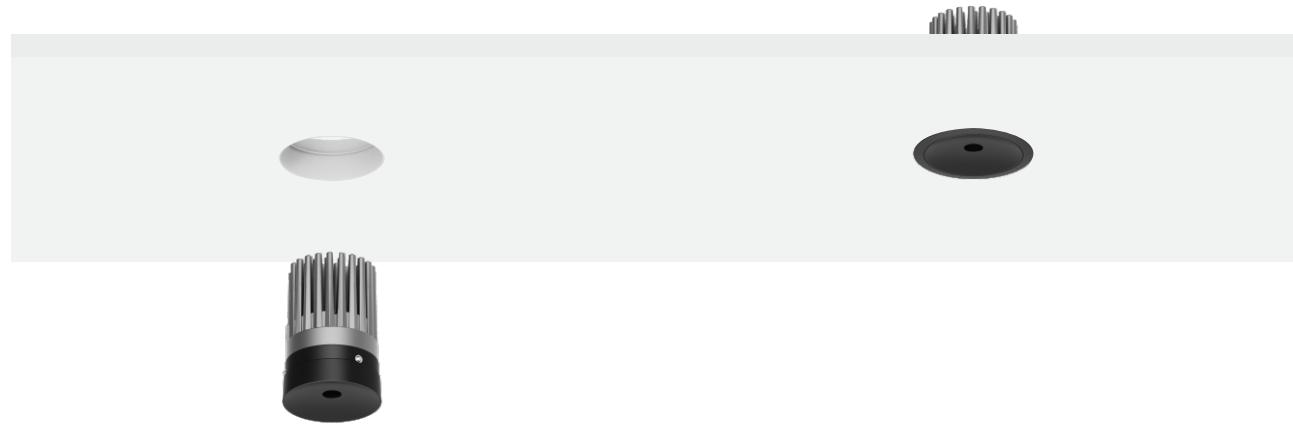

Body

The Cabin M is a recessed downlight featuring an ultra-compact Ø12 mm aperture, suitable for both trim and trimless installations.

It offers easy maintenance and is equipped with high-efficiency LEDs delivering excellent color rendering. This variant ensures broad compatibility with diverse ceiling types and finishes.

The internal trim can be discreetly concealed using matching ceiling materials, creating a seamless and uninterrupted ceiling aesthetic.

Optic

Lens.
Beam Angle: 24° / 36° / 50°.

LED Sources

Light source options: High-power LED or COB LED.
CRI: 95 or 97 | CCT: 2700K / 3000K / 3500K / 4000K.
Additional CRI and CCT options available upon request.

Finish

Powder coated finish in matt white (W), matt black (B).

Driver

Supplied with non-dimmable remote driver.
Driver unit exceeds luminaire aperture; install above ceiling using extension cable.
Dimming Options: ON/OFF | 0-10V | DALI | TRIAC | CASAMBI.
220-240V 50/60Hz.

Accessories

N/A

Applications

Its concealed light source for high visual comfort ensures this luminaire blends seamlessly into its architectural environment. With the added flexibility of light aiming.
Application areas: Corridors, retail, showrooms, residential, restaurants, hotels.

Optional

Trimless



Trimles



Cabin M Fixed Recessed

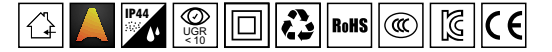

Cabin M
Fixed Round Trim Ø70mm

Cabin M
Fixed Round Trimless Ø120mm

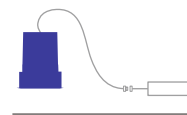
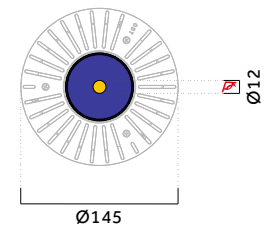
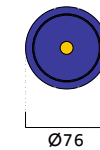
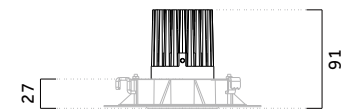
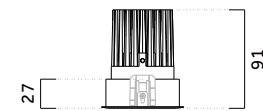

Code ordering example: * * . 7 0 9 1 . * * * * * * *

	Product code	LED Power	Nominal Lumen	Finish	Cup	Beam Angle (BA°)	CCT Options	Dimming Options
Cabin D Round Fixed	01 Trim	Max.16W	960lm	W White	W White	24 24°	27 2700K	0 ON/OFF
	30 Trimless			B Black	B Black	36 36°	30 3000K	1 0-10V
						50 50°	35 3500K	D DAIL
						40 4000K	T TRIAC	C CASAMBI

Adjustable Downlight

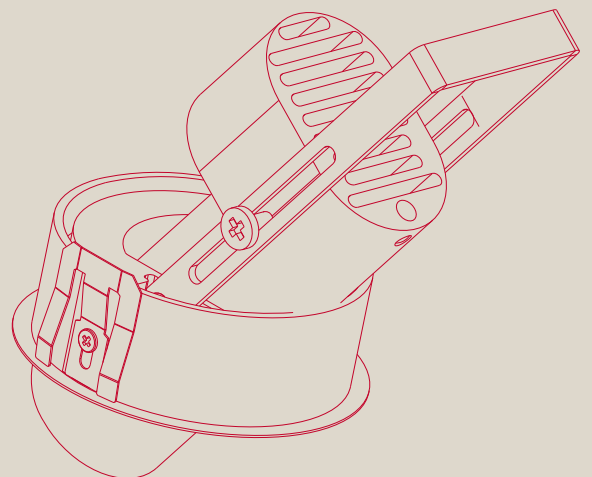
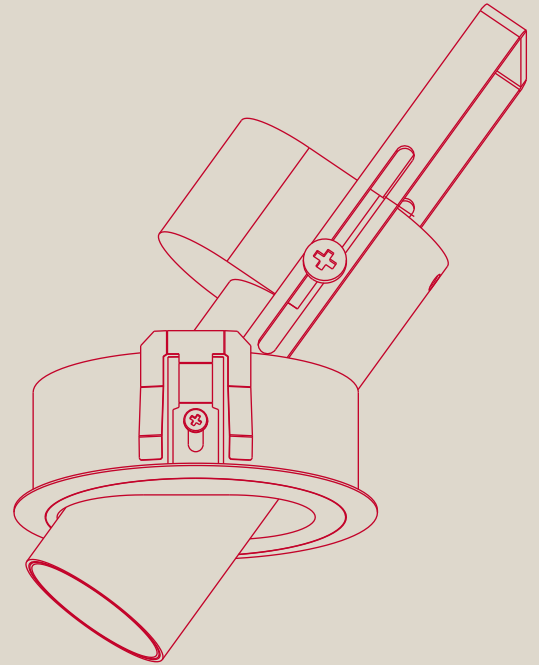



Adjustable Downlight





Lens

light is evolution

In the beginning, there was light, and light is evolution.
An evolution that is creative, that constantly renews itself
and that will never end. Light means life. Light quality
means quality of life!



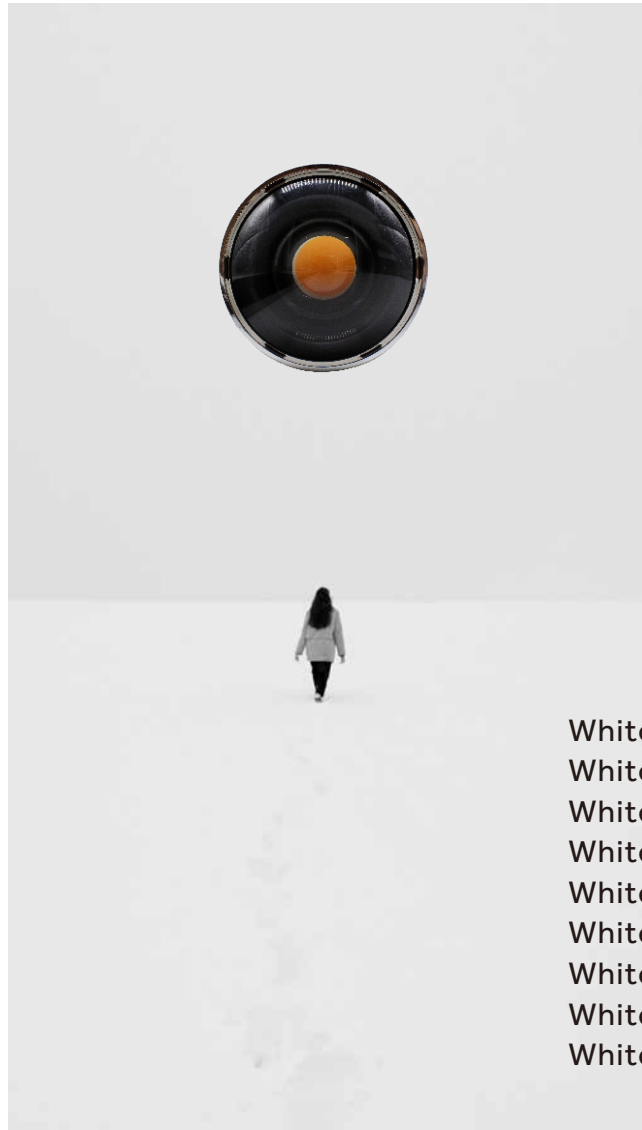

White is light
 White is innocent
 White is pure
 White disappears
 White is perfection
 White has no end
 White has no begin
 White is empty
 White is unwritten



OT Series Track System



48V Track OT 35 | 45 | 55 | 65

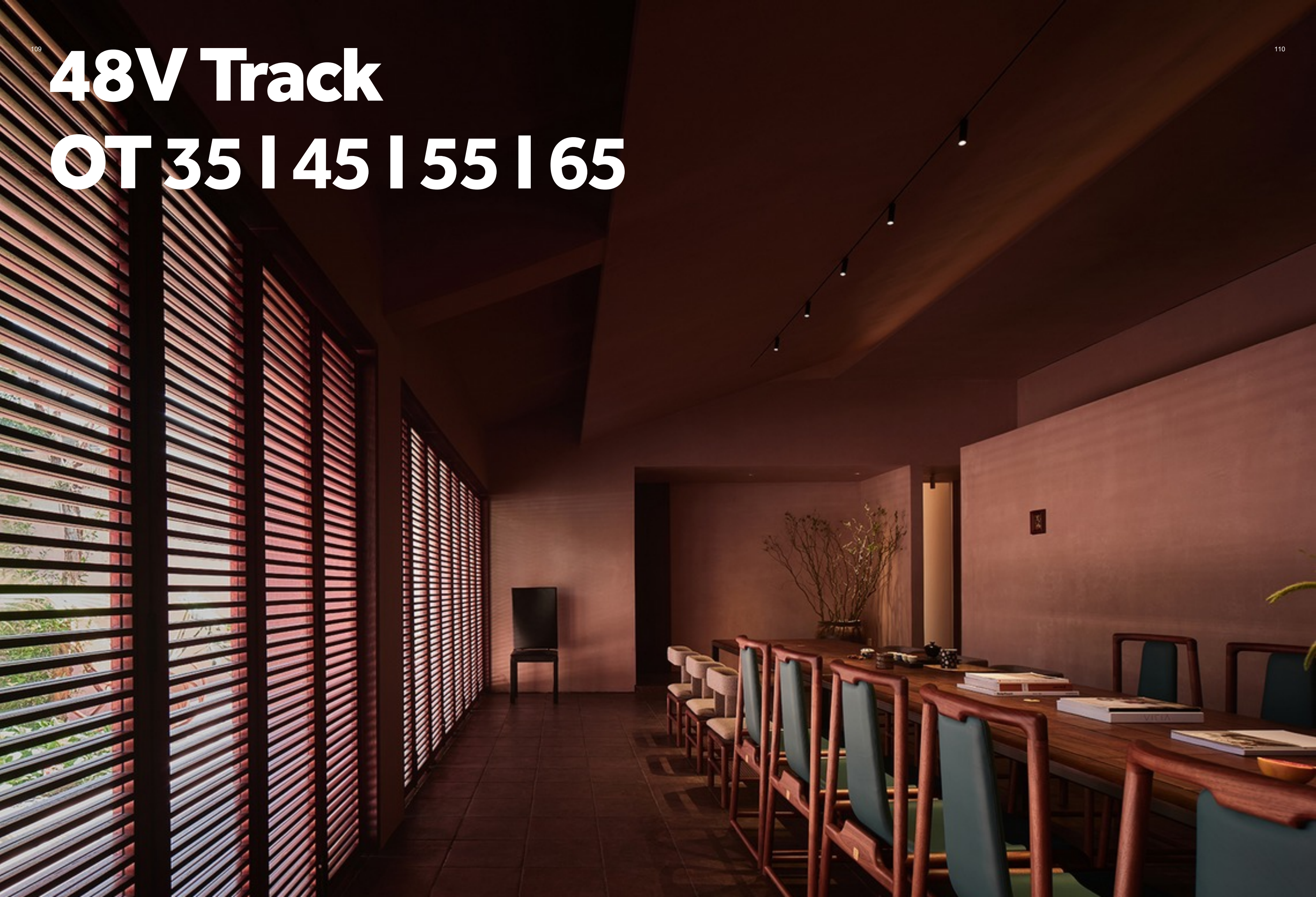

2.0 Series Track

48V Surface Mounted Track

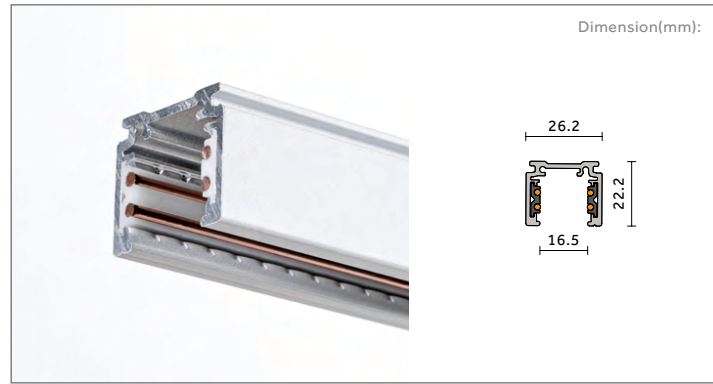

TRACK LENGTH	White	Black
1000mm	37.2610.WH	37.2610.BK
2000mm	37.2620.WH	37.2620.BK
3000mm	37.2630.WH	37.2630.BK

* A 350W driver is required to power up a single track (maximum length: 10m) with a maximum load of 170W per track.

37.2662.WH / 37.2662.BK
Flat Corner
90° corner on the same plane.

37.2664.WH / 37.2664.BK
Introvert Corner
90° corner between different planes, such as walls to ceiling.

37.2669.SI
Connection Plate x 2

37.2668.WH / 37.2668.BK
End Cap x 2

2.0 Track & Accessories

Surface / Pendant Mounted

"L" Power Supply Connector <p>37.2660.WH</p>		"R" Power Supply Connector <p>37.2661.WH</p>	
"L" Flat Corner <p>37.2662.WH</p>		"R" Flat Corner <p>37.2663.WH</p>	
Introvert Corner <p>37.2664.WH</p>			
"L" Connector <p>37.2666.WH</p>		"I" Connector <p>37.2665.WH</p>	
Flexible Connector <p>37.2667.WH</p>			
End Cap <p>37.2668.WH</p>		Connection Plate <p>37.2669.SI</p>	
Pendant Accessories <p>37.2670.WH</p>			
Track Cover Plate <p>37.2673.BK</p>		Ceiling Pendant Accessories <p>37.2671.SI</p>	
Ceiling Pendant Accessories <p>37.2672.SI</p>			

2.0 Series Deep Profile Track

48V Surface Mounted Deep Profile Track

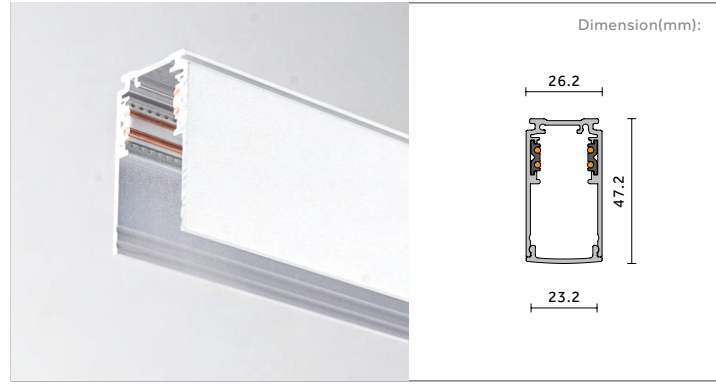

TRACK LENGTH	White	Black
1000mm	37.2310.WH	37.2310.BK
2000mm	37.2320.WH	37.2320.BK
3000mm	37.2330.WH	37.2330.BK

* A 350W driver is required to power up a single track (maximum length: 10m) with a maximum load of 170W per track.

37.2361.WH / 37.2362.BK
Flat Corner
90° corner on the same plane.

37.2363.WH / 37.2363.BK
Introvert Corner
90° corner between different planes, such as walls to ceiling.

37.2669.SI
Connection Plate x 2

37.2364.WH / 37.2364.BK
End Cap x 2

2.0 Track & Accessories

Surface / Pendant Mounted

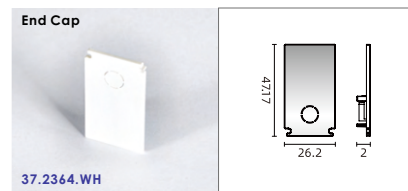
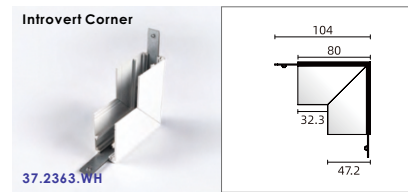
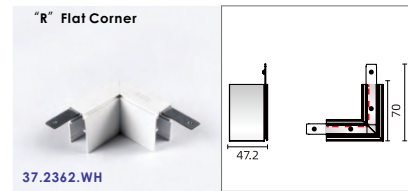
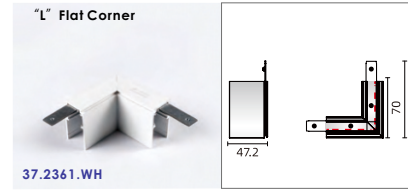

2.0 Series Recessed Track

48V Recessed Mounted (Pre-installation Required)

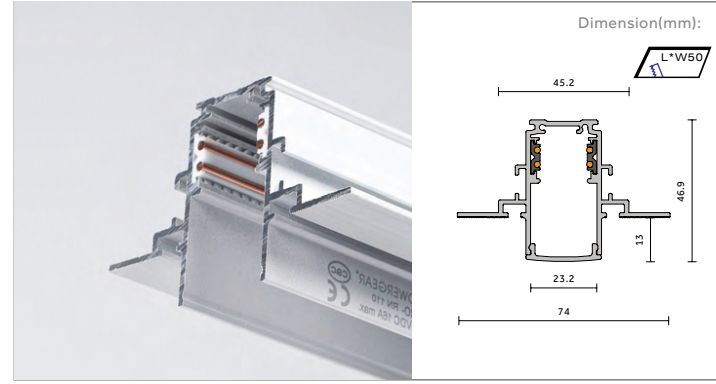

TRACK LENGTH	White	Black
1000mm	37.7410.WH	37.7410.BK
2000mm	37.7420.WH	37.7420.BK
3000mm	37.7430.WH	37.7430.BK

* A 350W driver is required to power up a single track (maximum length: 10m) with a maximum load of 170W per track.

37.7461.WH / 37.7462.BK
Flat Corner
90° corner on the same plane.

37.7463.WH / 37.7463.BK
Introvert Corner
90° corner between different planes, such as walls to ceiling.

37.7465.SI
Connection Plate x 2

37.7464.WH / 37.7464.BK
End Cap x 2

2.0 Track & Accessories

Recessed Mounted (Installation Beforehand)

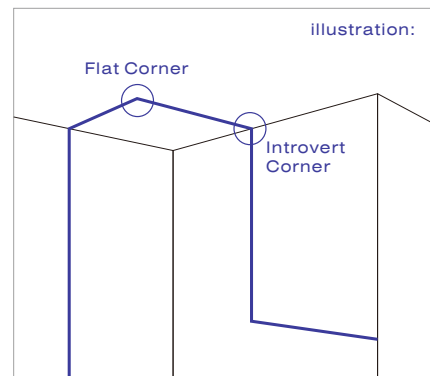
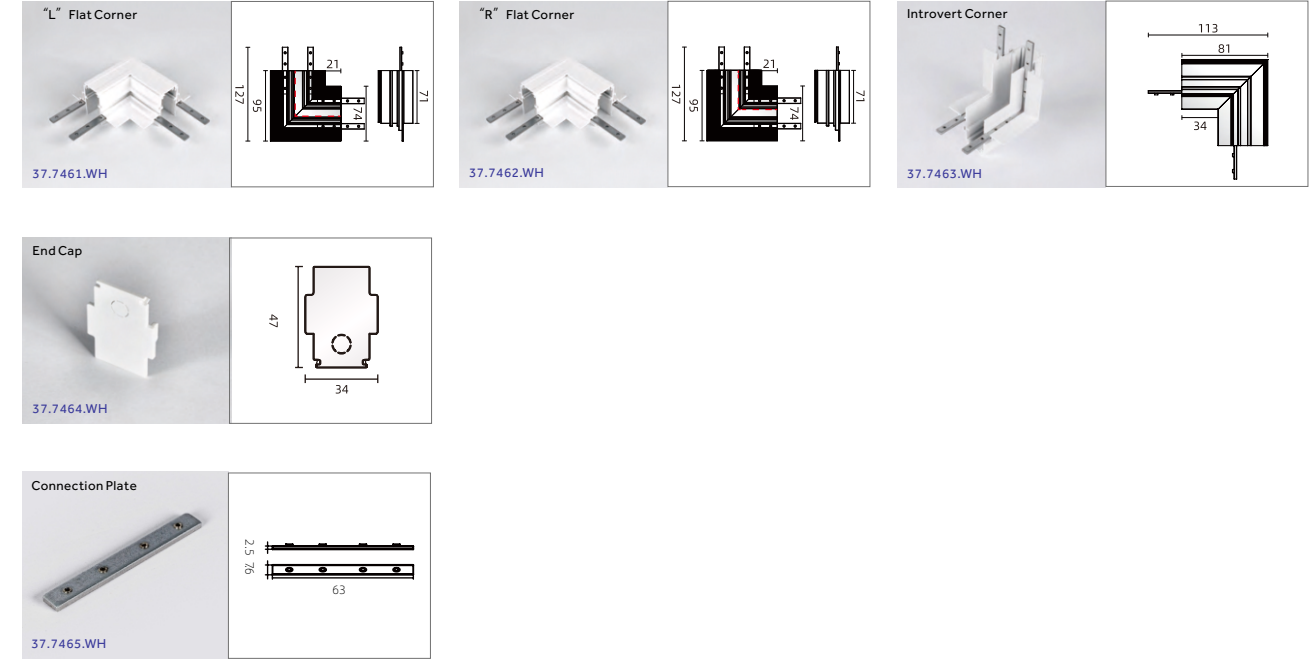

OT Ø35

48V Low Voltage Track



Body

The OT Low Voltage is an energy-saving, track-mounted low-voltage track system with an integrated driver, which focuses on modularity and eco-friendliness. The tool-free interchangeable LED module facilitates design flexibility and ease of on-site maintenance.

Available in four different adjustable light head sizes Ø35, Ø45, Ø55 and Ø65mm.

Adjustability: Tilt 90° | Rotation 355°.

Optic

Lens
Beam Angle: 15° / 24° / 36°.

Finish

Powder coated finish in matt white (W), matt black (B), and chrome (H).

LED Sources

Light source options: High-power LED or COB LED.
CRI: 95 or 97 | CCT: 2700K / 3000K / 3500K / 4000K.
Additional CRI and CCT options available upon request.

Applications

Compact, efficient, and powerful, with excellent color rendering and different color temperature options.
Application areas: Ideal for lighting retail environments.

OT Ø35 48V Low Voltage Track

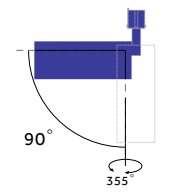
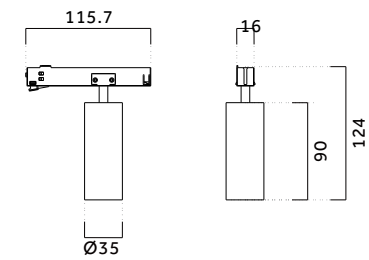
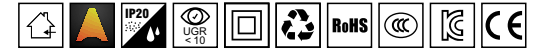

Code ordering example: * * . 3 5 0 8 . * * * * * *

	Product code	LED Power	Nominal Lumen	Finish	Cup	Beam Angle (BA°)	CCT Options	Dimming Options
OT 35	32 48V	Max.8W	800lm	W White	W White	15 15°	27 2700K	0 ON/OFF
48V Track				B Black	B Black	24 24°	30 3000K	1 0-10V
				H Chrome		36 36°	35 3500K	D DAIL
							40 4000K	T TRIAC
								C CASAMBI

OT Ø45

48V Low Voltage Track



OT Ø45 48V Low Voltage Track

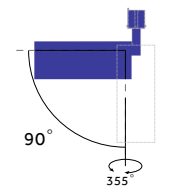
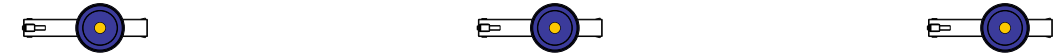
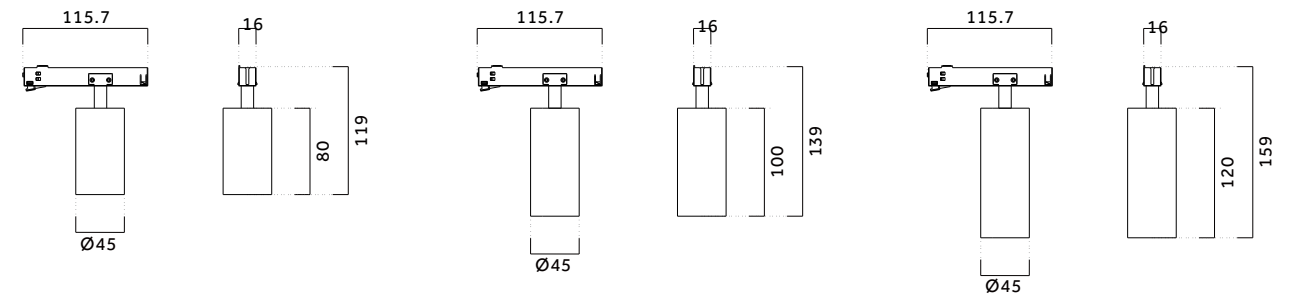
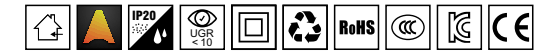

Code ordering example: $\underline{\quad}$ * * . $\underline{4}$ $\underline{5}$ $\underline{0}$ $\underline{9}$. * * * * * * * * (Max.9.3W) $\underline{\quad}$ * * . $\underline{4}$ $\underline{5}$ $\underline{1}$ $\underline{5}$. * * * * * * * * (Max.15W)
 $\underline{\quad}$ * * . $\underline{4}$ $\underline{5}$ $\underline{1}$ $\underline{2}$. * * * * * * * * (Max.12W)

	Product code	LED Power	Nominal Lumen	Finish	Cup	Beam Angle (BA°)	CCT Options	Dimming Options
OT 45	32 48V	Max.9.3W	930lm	W White	W White	15 15°	27 2700K	0 ON/OFF
48V Track		Max.12W	1200lm	B Black	B Black	24 24°	30 3000K	1 0-10V
		Max.15W	1500lm	H Chrome		36 36°	35 3500K	D DAIL
							40 4000K	T TRIAC C CASAMBI

OT Ø55

48V Low Voltage Track



OT Ø55 48V Low Voltage Track

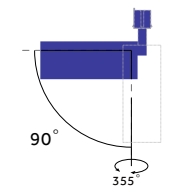
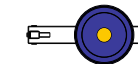
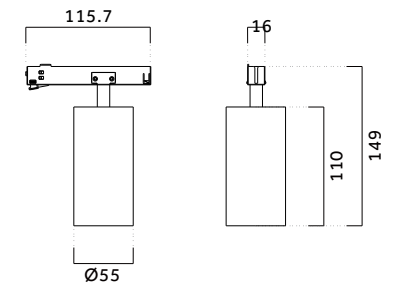
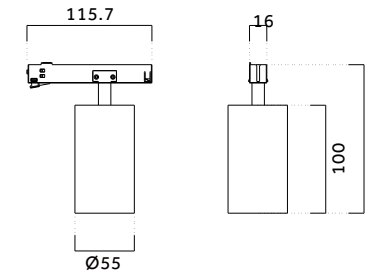
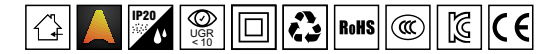

Code ordering example: $\frac{**}{\text{ }} \cdot \frac{5515}{\text{ }} \cdot \frac{*****}{\text{ }} \cdot \frac{*****}{\text{ }} \cdot \frac{5518}{\text{ }} \cdot \frac{*****}{\text{ }} \cdot \frac{*****}{\text{ }} \cdot \frac{*****}{\text{ }}$ (Max.15.2W) $\frac{**}{\text{ }} \cdot \frac{5518}{\text{ }} \cdot \frac{*****}{\text{ }} \cdot \frac{*****}{\text{ }} \cdot \frac{*****}{\text{ }}$ (Max.18W)

	Product code	LED Power	Nominal Lumen	Finish	Cup	Beam Angle (BA°)	CCT Options	Dimming Options
OT 55	32 48V	Max.15.2W	1520lm	W White	W White	15 15°	27 2700K	0 ON/OFF
48V Track		Max.18W	1800lm	B Black	B Black	24 24°	30 3000K	1 0-10V
				H Chrome	N Gun Black	36 36°	35 3500K	D DAIL
							40 4000K	T TRIAC
								C CASAMBI

OT Ø65

48V Low Voltage Track

OT Ø65

48V Low Voltage Track

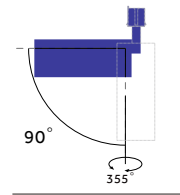
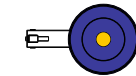
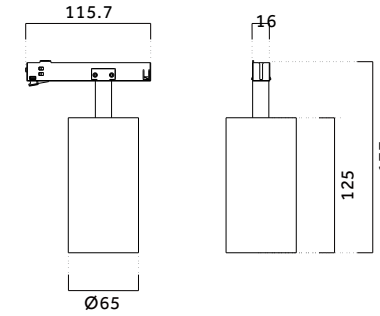
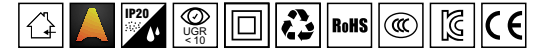

Code ordering example: . .

	Product code	LED Power	Nominal Lumen	Finish	Cup	Beam Angle (BA°)	CCT Options	Dimming Options
OT 65	32 48V	Max.20W	1700lm	W White	W White	15 15°	27 2700K	0 ON/OFF
48V Track				B Black	B Black	24 24°	30 3000K	1 0-10V
				H Chrome		36 36°	35 3500K	D DAIL
							40 4000K	T TRIAC
								C CASAMBI

Track & Accessories

3-Wire Single Circuit Track System

SURFACE MOUNTED TRACK

Surface mounted universal track with 3 wire conductors.

TRACK LENGTH	White	Black
1000mm	25.3410.WH	25.3410.BK
1500mm	25.3415.WH	25.3415.BK
2000mm	25.3420.WH	25.3420.BK

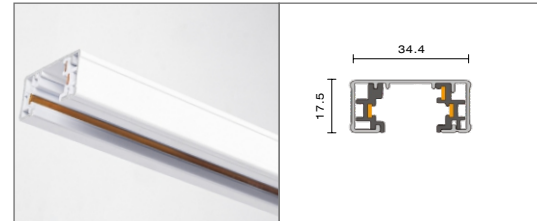

RECESSED TRACK

Recessed mounted universal track with 3 wire conductors.

TRACK LENGTH	White	Black
1000mm	25.5010.WH	25.5010.BK
1500mm	25.5015.WH	25.5015.BK
2000mm	25.5020.WH	25.5020.BK

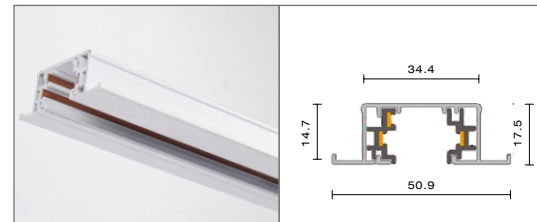

LIVE END CONNECTOR

Wiring terminal for mains connection.

POLARITY	White	Black
	25.3401.WH	25.3401.BK

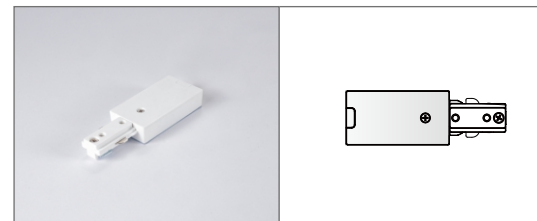

STRAIGHT CONNECTOR

For interconnecting 2 track sections.

TRACK	White	Black
	25.3403.WH	25.3403.BK

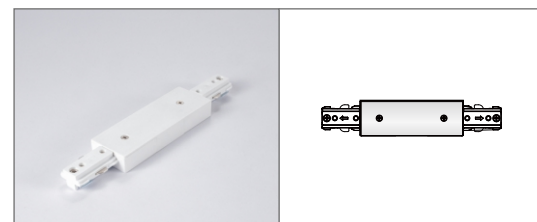

END CAP

Cover for end of track.

TRACK	White	Black
	25.3413.WH	25.3413.BK



Track & Accessories

3 Wires Single Circuit Track System

FLEXIBLE CONNECTOR

For interconnecting 2 track sections flexibly at any angle up to 90°.

TRACK	White	Black
	25.3404.WH	25.3404.BK

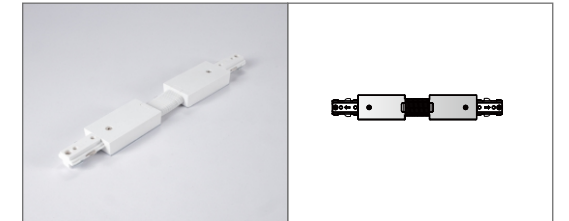

"L"CONNECTOR

For interconnecting 2 track sections at 90° angle.

POLARITY	White	Black
	25.3405.WH	25.3405.BK

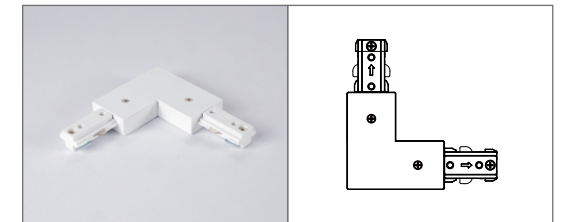

"X"CONNECTOR

For interconnecting 4 track sections in a X-configuration.

TRACK	White	Black
	25.3412.WH	25.3412.BK

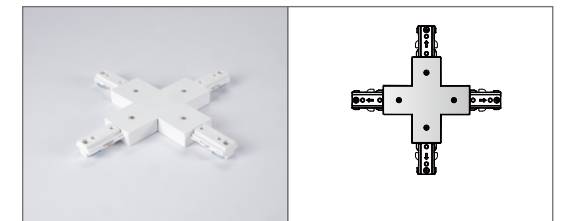

STRAIGHT CONNECTOR

For interconnecting 2 track sections.

LENGTH	White	Black
	25.3406.WH	25.3406.BK

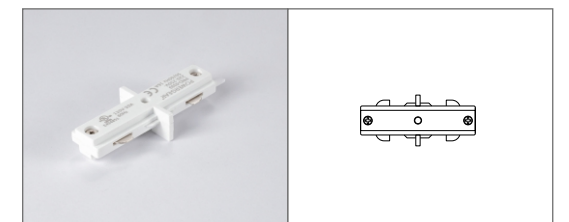

"T"CONNECTOR

For interconnecting 3 track sections in a T-configuration.

POLARITY	White	Black
	25.3407.WH	25.3407.BK

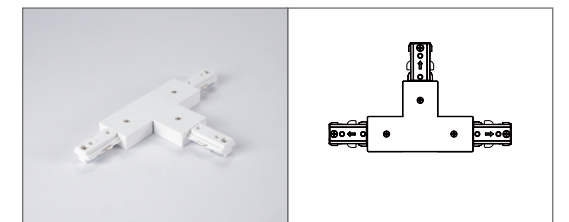

Track & Accessories

4-Wire 3-Circuit Track System

SURFACE MOUNTED TRACK

Surface mounted universal track with 4 wire conductors.

TRACK LENGTH	White	Black
1000mm	25.3210.WH	25.3210.BK
1500mm	25.3215.WH	25.3215.BK
2000mm	25.3220.WH	25.3220.BK

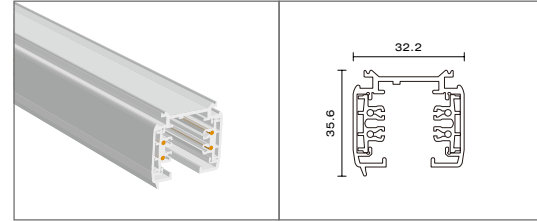

RECESSED MOUNTED TRACK

Recessed mounted universal track with 4 wire conductors.

TRACK LENGTH	White	Black
1000mm	25.5610.WH	25.5610.BK
1500mm	25.5615.WH	25.5615.BK
2000mm	25.5620.WH	25.5620.BK

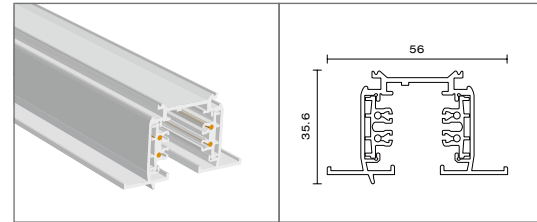

LIVE END CONNECTOR

Wiring terminal for mains connection.

POLARITY	White	Black
Left	25.3201.WH	25.3201.BK
Right	25.3202.WH	25.3202.BK

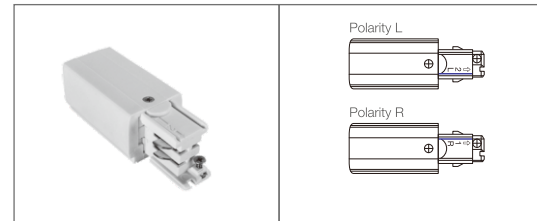

STRAIGHT CONNECTOR

For interconnecting 2 track sections.

TRACK	White	Black
	25.3203.WH	25.3203.BK

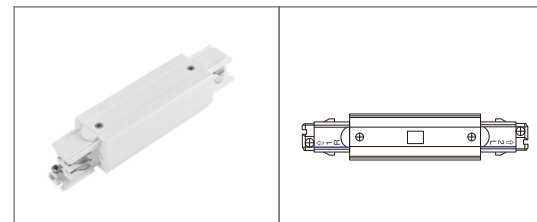

END CAP

Cover for end of track.

TRACK	White	Black
	25.3213.WH	25.3213.BK

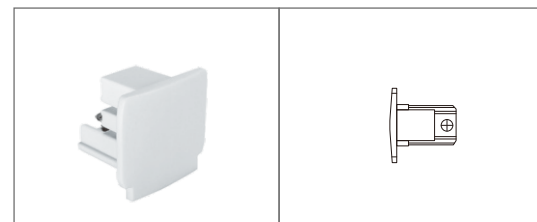

Track & Accessories

4 Wires 3 Circuits Track System

FLEXIBLE CONNECTOR

For interconnecting 2 track sections flexibly at any angle up to 90°.

TRACK	White	Black
	25.3204.WH	25.3204.BK

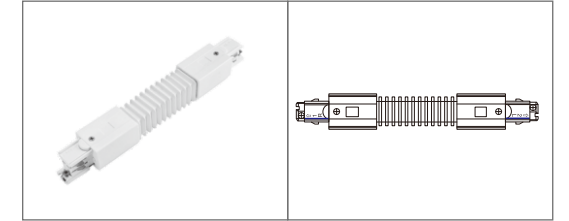

"L"CONNECTOR

For interconnecting 2 track sections at 90° angle.

POLARITY	White	Black
Left	25.3205.WH	25.3205.BK
Right	25.3206.WH	25.3206.BK

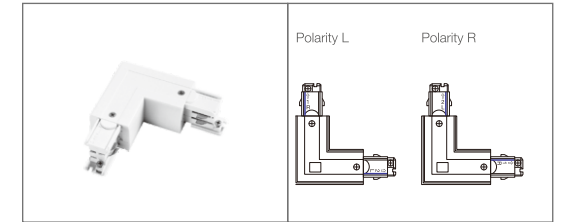

"X"CONNECTOR

For interconnecting 4 track sections in a X-configuration.

TRACK	White	Black
	25.3212.WH	25.3212.BK

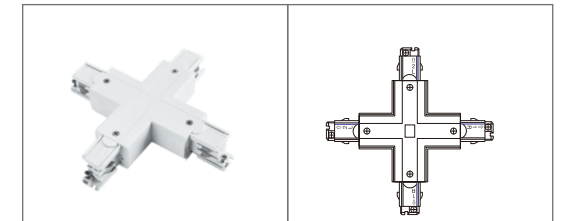

SUSPENSION KIT

For suspending the track system with steel wire or rod.

LENGTH	White	Black
1.5m Steel Wire	25.3214.WH	25.3214.BK
1.5m Rod M6	25.3218.WH	25.3218.BK

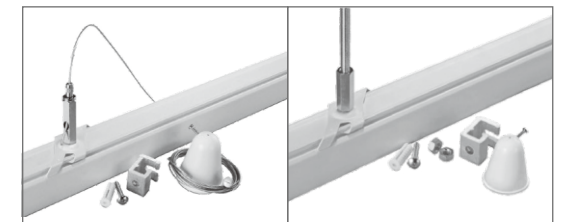

"T"CONNECTOR

For interconnecting 3 track sections in a T-configuration.

POLARITY	White	Black
Left 1	25.3207.WH	25.3207.BK
Left 2	25.3208.WH	25.3208.BK
Right 1	25.3209.WH	25.3209.BK
Right 2	25.3211.WH	25.3211.BK

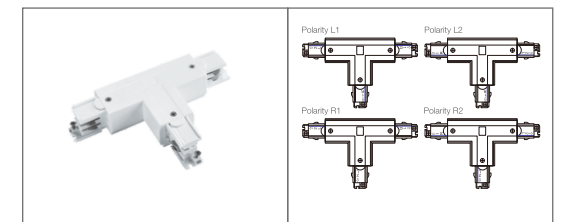

OT-S Ø45

3/4-Phase Track

Body

OT-S track-mounted spotlight with light head and mounting arm. Available in three light head diameters: 50mm, 55mm, and 65mm. The integrated track adapter with built-in driver is compatible with 3-phase track.

Two DC motors enable fixture movement: vertical tilting up to 90° and horizontal rotation of 315°. For the OT series, a third motor adjusts the light beam from narrow to wide diffusion. The movements, beam shaping, intensity, and colour tuning are controlled via CASAMBI™ application.

Optic

Lens.
Beam Angle: 15° / 24° / 36°

LED Sources

Light source options: High-power LED or COB LED.
CRI: 95 or 97 | CCT: 2700K / 3000K / 3500K / 4000K.
Additional CRI and CCT options available upon request.

Finish

Powder coated finish in matt white (W), matt black (B), and chrome (H).

Applications

Compact, efficient, and powerful, with excellent color rendering and different color temperature options.
Application areas: Ideal for lighting retail environments.

OT-S Ø45

3/4 Phase Track

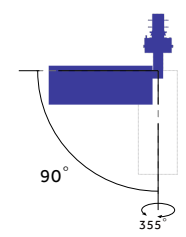
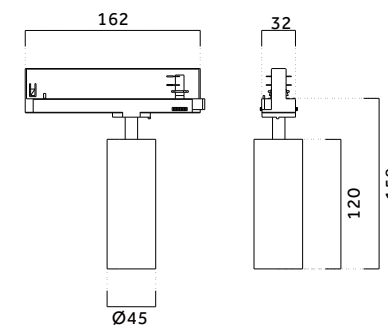

Code ordering example: * * . 4 5 1 5 . * * * * * *

	Product code	LED Power	Nominal Lumen	Finish	Cup	Beam Angle (BA°)	CCT Options	Dimming Options
3 Phase Track	25 220V	Max.15W	1500lm	W White	W White	15 15°	27 2700K	0 ON/OFF
4 Phase Track	26 220V			B Black	B Black	24 24°	30 3000K	1 0-10V
				H Chrome		36 36°	35 3500K	D DAIL
							40 4000K	T TRIAC
							C CASAMBI	

OT-S Ø55

3/4-Phase Track



OT-S Ø55 3/4 Phase Track

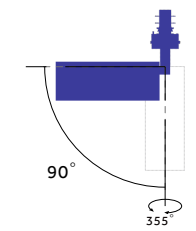
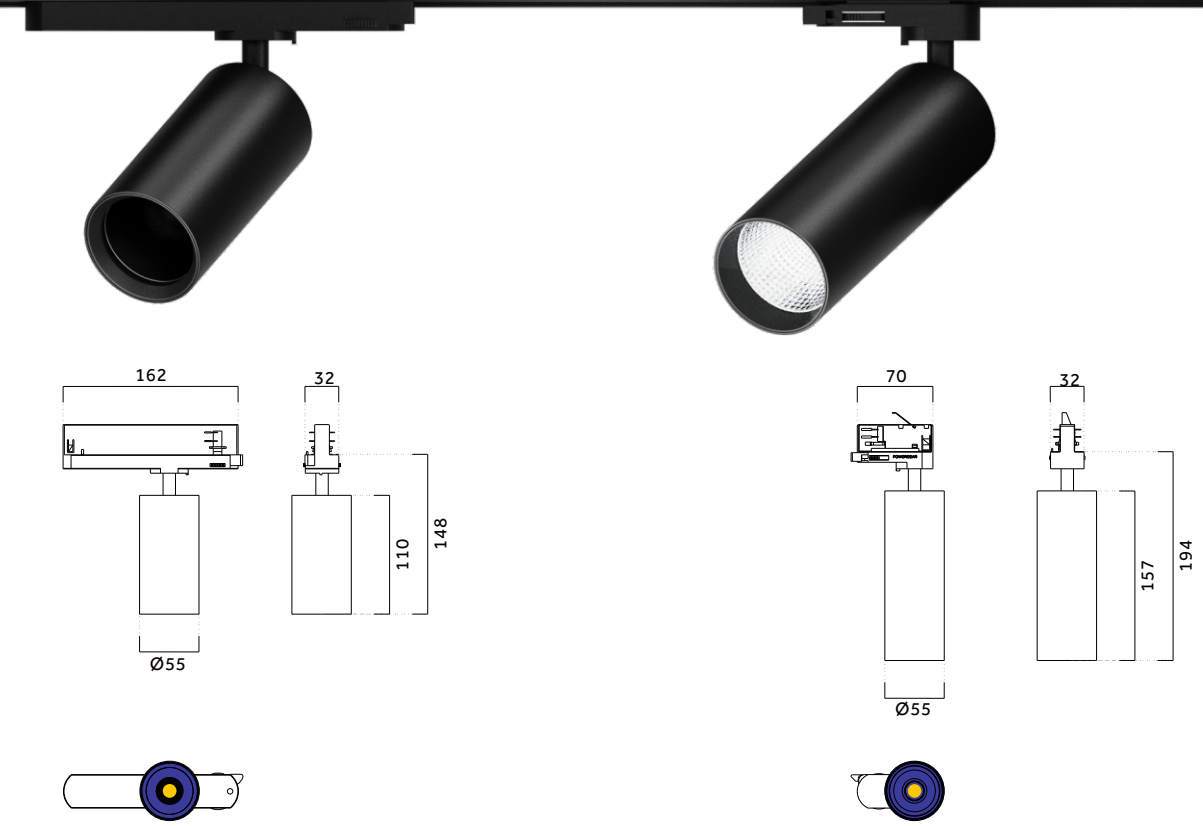
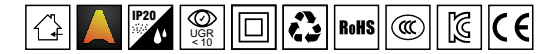

Code ordering example: . . (Lens) . (Reflector cup)

	Product code	LED Power	Nominal Lumen	Finish	Cup	Beam Angle (BA°)	CCT Options	Dimming Options
3 Phase Track	25 220V	Max.15W	1275lm	W White	W White	15 15°	27 2700K	0 ON/OFF
4 Phase Track	26 220V	Max.18W	1800lm	B Black	B Black	24 24°	30 3000K	1 0-10V
				H Chrome	N Gun Black	36 36°	35 3500K	D DAIL
							40 4000K	T TRIAC
								C CASAMBI

OT-R Ø35

Adjustable Recessed

Body

The novel appearance of the back cover and leg, with special structure, fixture can be adjusted more than 200 times.

This series has 2 sizes and 2 wattages, which can well meet the needs of different places.

Finish

Powder coated finish in matt white (W), matt black (B), and chrome (H)

Driver

Supplied with non-dimmable remote driver.
Driver unit exceeds luminaire aperture; install above ceiling using extension cable.
Dimming Options: ON/OFF | 0-10V | DALI | TRIAC | CASAMBI.
220-240V 50/60Hz.

Optic

Lens.
Beam Angle: 15° / 24° / 36°.

LED Sources

Light source options: High-power LED or COB LED.
CRI: 95 or 97 | CCT: 2700K / 3000K / 3500K / 4000K.
Additional CRI and CCT options available upon request.

Accessories

N/A

Applications

Compact, efficient, and powerful, with excellent color rendering and different color temperature options.
Application areas: ideal for lighting retail environments.

OT-D Ø35

Adjustable Recessed

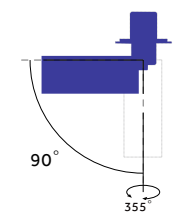
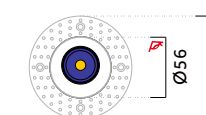
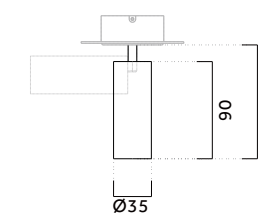
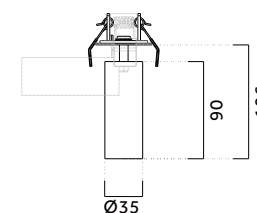
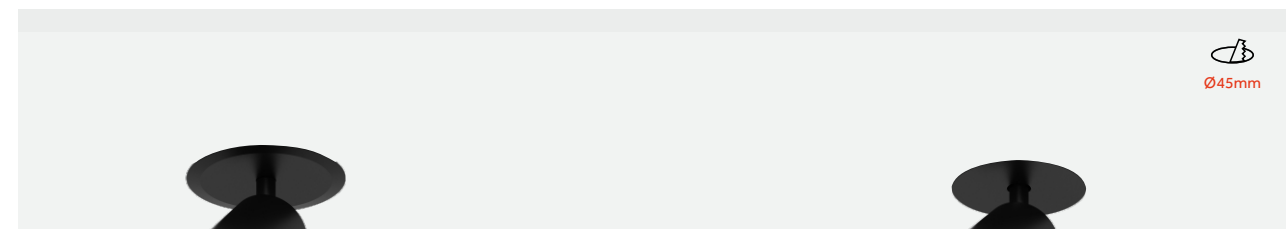

Code ordering example: * * . 3 5 0 8 . * * * * * *

	Product code	LED Power	Nominal Lumen	Finish	Cup	Beam Angle (BA°)	CCT Options	Dimming Options
OT-D 35	03 Trim	Max.8W	800lm	W White	W White	15 15°	27 2700K	0 ON/OFF
Round	12 Trimless			B Black	B Black	24 24°	30 3000K	1 0-10V
Adjustable				H Chrome		36 36°	35 3500K	D DAIL
							40 4000K	T TRIAC
								C CASAMBI

OT-R Ø45

Adjustable Recessed



OT-D Ø45

Adjustable Recessed

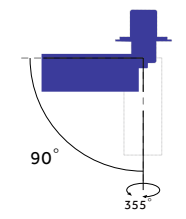
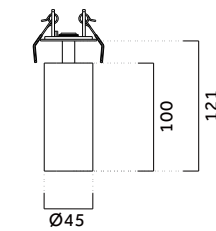
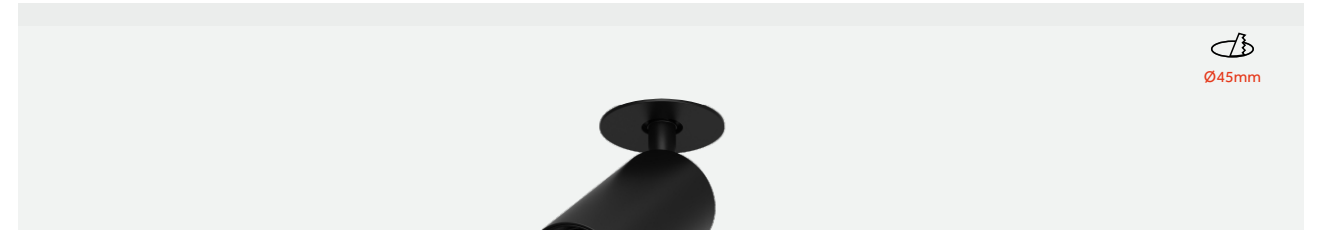
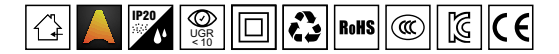

Code ordering example: * * . 4 5 1 8 . * * * * * *

	Product code	LED Power	Nominal Lumen	Finish	Cup	Beam Angle (BA°)	CCT Options	Dimming Options
OT-D 35	03 Trim	Max.10W	1000lm	W White	W White	15 15°	27 2700K	0 ON/OFF
Round	12 Trimless			B Black	B Black	24 24°	30 3000K	1 0-10V
Adjustable				H Chrome		36 36°	35 3500K 40 4000K	D DAIL T TRIAC C CASAMBI

OT-W Ø35

Adjustable Wall Mounted

Body

Long and thin, blends in well with the space. Small diameter, high wattage.

A range of luminaires designed primarily for spaces with restricted heights and no suspended ceilings. Can be horizontally at 90 degrees and rotated at 350 degrees.

Optic

Lens.
Beam Angle: 15° / 24° / 36°

LED Sources

Light source options: High-power LED or COB LED.
CRI: 93 or 97 | CCT: 2700K / 3000K / 3500K / 4000K.
Additional CRI and CCT options available upon request.

Finish

Powder coated finish in matt white (W), matt black (B), chrome (H) and copper (C).

Driver

Supplied with non-dimmable remote driver.
Dimming Options: ON/OFF | 0-10V | DALI | TRIAC | CASAMBI.
220-240V 50/60Hz.

Accessories

N/A

Applications

Compact, efficient, and powerful, with excellent color rendering and different color temperature options.
Application areas: Ideal for lighting retail environments.

OT-W Ø35

Adjustable Wall Mounted

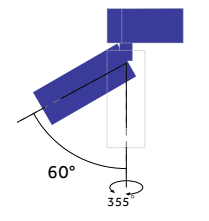
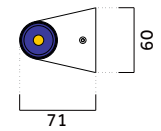
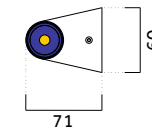
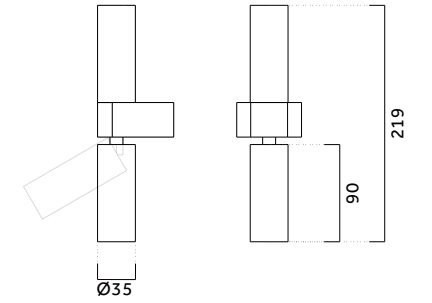
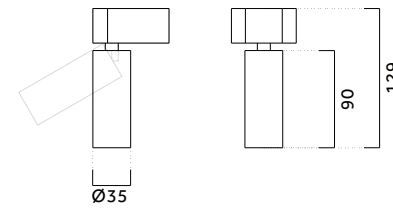
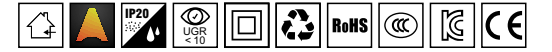

Code ordering example: **3 5 9 0** (Max.6W) **3 5 9 1** (Max.12W)

	Product code	LED Power	Nominal Lumen	Finish	Cup	Beam Angle (BA°)	CCT Options	Dimming Options
OT-W 35	52 220V	Max.6W	600lm	W White	W White	15 15°	27 2700K	0 ON/OFF
Adjustable		Max.2*6W	1200lm	B Black	B Black	24 24°	30 3000K	1 0-10V
Wall Mounted				H Chrome		36 36°	35 3500K	D DAIL
				C Copper			40 4000K	T TRIAC
								C CASAMBI

OT-M Ø35

Adjustable Ceiling Surface



Body

Surface mounted light, CNC machining, luminaire surface can support electroplating treatment. With anti-glare and high efficiency optics.

Classic and durable, suitable for spaces with restricted ceiling heights.

Finish

Powder coated finish in matt white (W), matt black (B), chrome (H) and copper (C).

Driver

Supplied with non-dimmable remote driver.
Dimming Options: ON/OFF | 0-10V | DALI | TRIAC | CASAMBI.
220-240V 50/60Hz.

Optic

Lens.
Beam Angle: 15° / 24° / 36°.

Accessories

N/A

LED Sources

Light source options: High-power LED or COB LED.
CRI: 95 or 97 | CCT: 2700K / 3000K / 3500K / 4000K.
Additional CRI and CCT options available upon request.

Applications

Compact, efficient, and powerful, with excellent color rendering and different color temperature options.
Application areas: Ideal for lighting retail environments.

OT-M Ø35

Adjustable Ceiling Surface

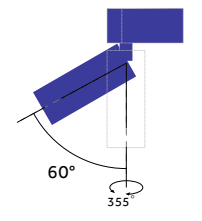
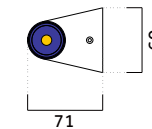
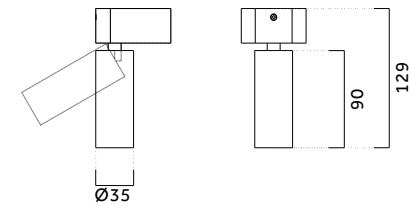
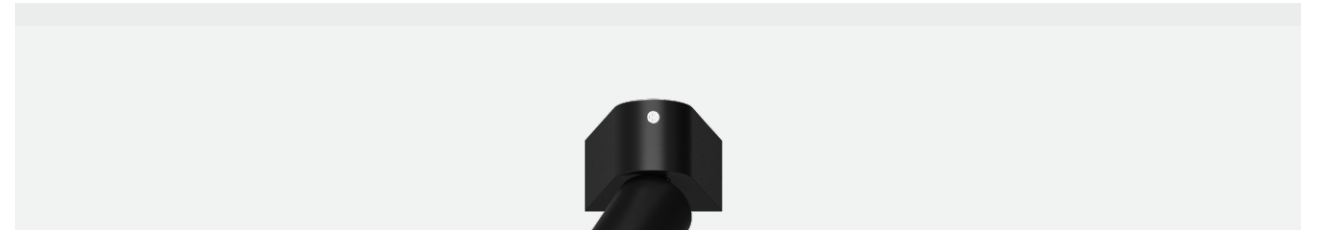
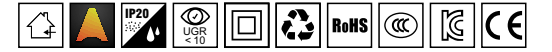

Code ordering example: * * . 3 5 2 9 . * * * * * *

	Product code	LED Power	Nominal Lumen	Finish	Cup	Beam Angle (BA°)	CCT Options	Dimming Options
OT-M 35	52 220V	Max.6W	600lm	W White	W White	15 15°	27 2700K	0 ON/OFF
Surface				B Black	B Black	24 24°	30 3000K	1 0-10V
Adjustable				H Chrome		36 36°	35 3500K	D DAIL
				C Copper			40 4000K	T TRIAC
								C CASAMBI

OT-T

48V Low Voltage Track

Body

The OT-T Low Voltage is an energy-saving, track-mounted, low-voltage track system with an integrated driver, focusing on modularity and eco-friendliness. The tool-free interchangeable LED module facilitates design flexibility and ease of maintenance.

Available in three adjustable light head sizes: Ø45mm, Ø60mm, and Ø80mm, with versatile aiming angles: tiltable 0°-90° and rotatable 355°.

Optic

Lens.
Beam Angle: 15° / 24° / 36°.

LED Sources

Light source options: High-power LED or COB LED.
CRI: 95 or 97 | CCT: 2700K / 3000K / 3500K / 4000K.
Additional CRI and CCT options available upon request.

Finish

Powder coated finish in matt white (W), matt black (B), and chrome (H).

Applications

Application areas: clothing shops, furniture shops and other brand boutiques, car displays, jewelry, star hotels, high-end clubs, museums, professional windows, and other high-end commercial places.

OT-T Ø35 | Ø60 | Ø80

48V Low Voltage Track

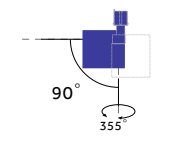
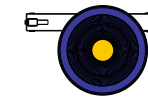
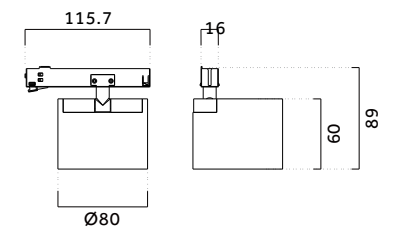
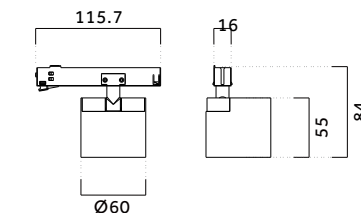
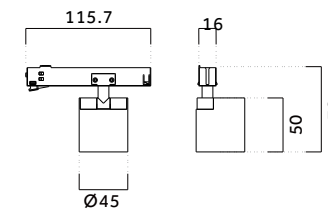
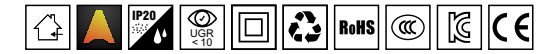

Code ordering example: $\underline{\quad} \underline{\quad} \cdot \underline{4} \underline{5} \underline{5} \underline{0} \cdot \underline{\quad} \underline{\quad} \underline{\quad} \underline{\quad} \underline{\quad} \underline{\quad}$ (Max.5W) $\underline{\quad} \underline{\quad} \cdot \underline{6} \underline{0} \underline{5} \underline{5} \cdot \underline{\quad} \underline{\quad} \underline{\quad} \underline{\quad} \underline{\quad} \underline{\quad}$ (Max.8.5W)
 $\underline{\quad} \underline{\quad} \cdot \underline{8} \underline{0} \underline{6} \underline{0} \cdot \underline{\quad} \underline{\quad} \underline{\quad} \underline{\quad} \underline{\quad} \underline{\quad}$ (Max.13W)

	Product code	LED Power	Nominal Lumen	Finish	Cup	Beam Angle (BA°)	CCT Options	Dimming Options
OT-T	32 48V	Max.5W	500lm	W White	W White	15 15°	27 2700K	0 ON/OFF
48V Track		Max.8.5W	850lm	B Black	B Black	24 24°	30 3000K	1 0-10V
		Max.13W	1300lm	H Chrome		36 36°	35 3500K	D DAIL
							40 4000K	T TRIAC C CASAMBI

OT-Q

3/4-Phase Track



OT-M Ø35 | Ø60 | Ø80 3/4 Phase Track

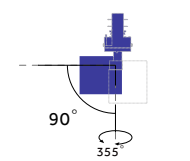
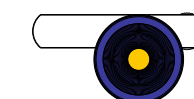
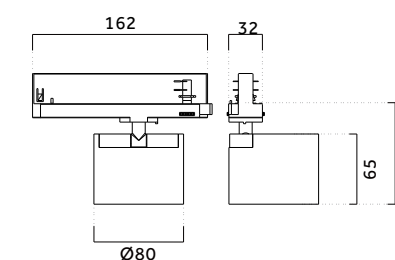
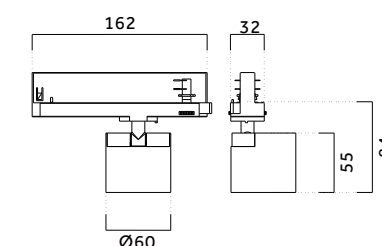
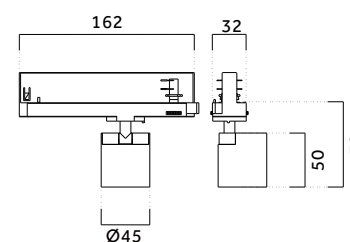

Code ordering example: $\underline{\quad}$ * * . $\underline{4550}$. * * * * * * * * * * (Max.5W) $\underline{\quad}$ * * . $\underline{6055}$. * * * * * * * * * * (Max.8.5W)
 $\underline{\quad}$ * * . $\underline{8060}$. * * * * * * * * * * (Max.13W)

	Product code	LED Power	Nominal Lumen	Finish	Cup	Beam Angle (BA°)	CCT Options	Dimming Options
3 Phase Track	25 220V	Max.5W	500lm	W White	W White	15 15°	27 2700K	0 ON/OFF
4 Phase Track	26 220V	Max.8.5W	850lm	B Black	B Black	24 24°	30 3000K	1 0-10V
		Max.13W	1300lm	H Chrome		36 36°	35 3500K	D DAIL
							40 4000K	T TRIAC
							C CASAMBI	

OT-L

Adjustable Recessed

Body

Available in AC 220 integrated, 48V magnetic, surface mounted and suspended, a wide range of solutions with light sources and optics for all your lighting needs.

Special back cover construction, can be adjusted 200 times without loosening, perfect proportions.

Optic

Lens
Beam Angle: 15° / 24° / 36° / 50°

LED Sources

Light source options: High-power LED or COB LED.
CRI: 95 or 97 | CCT: 2700K / 3000K / 3500K / 4000K.
Additional CRI and CCT options available upon request.

Finish

Powder coated finish in matt white (W), matt black (B), and chrome (H)

Driver

Supplied with non-dimmable remote driver.
Driver unit exceeds luminaire aperture; install above ceiling using extension cable.
Dimming Options: ON/OFF | 0-10V | DALI | TRIAC | CASAMBI.
220-240V 50/60Hz.

Accessories

N/A

Applications

Mainly used in high-end commercial space (clothing shops, furniture shops and other brand boutiques, car displays, jewelry, star hotels, highend clubs, museums, chain stores, brand sales halls, professional windows, counters and other accent lighting places).

OT-L Ø35 | Ø60 | Ø80

Adjustable Recessed

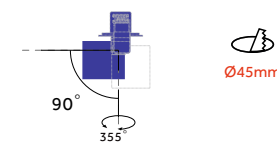
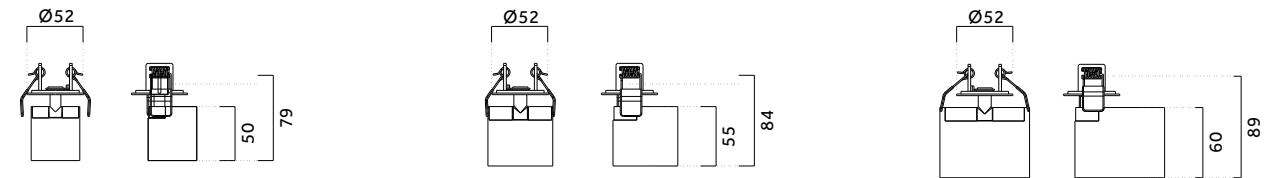
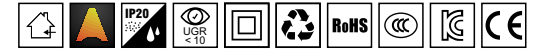

Code ordering example: $\underline{\quad}$ * * . $\underline{4550}$. * * * * * * * * * * (Max.5W) $\underline{\quad}$ * * . $\underline{6055}$. * * * * * * * * * * (Max.8.5W)
 $\underline{\quad}$ * * . $\underline{8060}$. * * * * * * * * * * (Max.13W)

	Product code	LED Power	Nominal Lumen	Finish	Cup	Beam Angle (BA°)	CCT Options	Dimming Options
OT-L	03 Trim	Max.5W	500lm	W White	W White	15 15°	27 2700K	0 ON/OFF
Round		Max.8.5W	850lm	B Black	B Black	24 24°	30 3000K	1 0-10V
Adjustable		Max.13W	1300lm	H Chrome		36 36°	35 3500K	D DALI
				C Copper		50 50°	40 4000K	T TRIAC
								C CASAMBI

Scout Series

light set them
into motion

lights that change
everything

2019/06/18

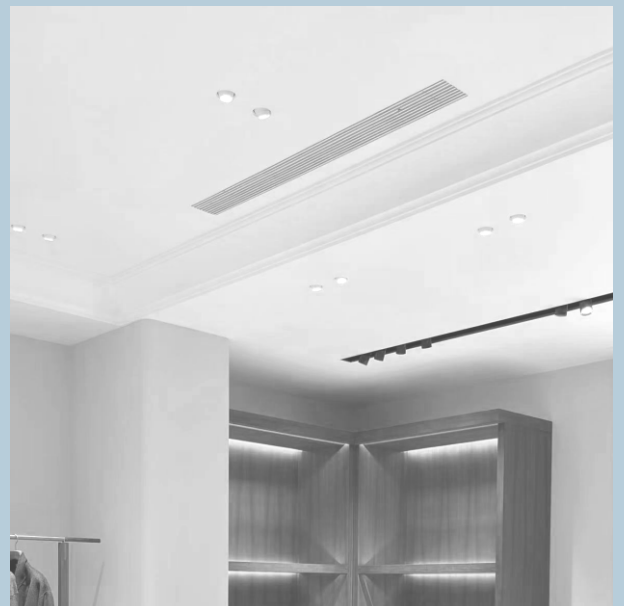

Edge forms system Spotlight units
are mounted on the top or side
of channel interior.

Scout Track

Slotting And Fixing Diagram

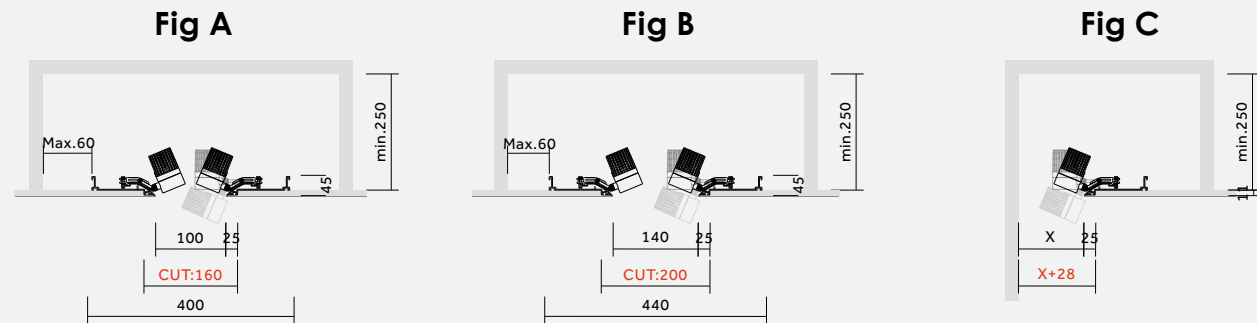
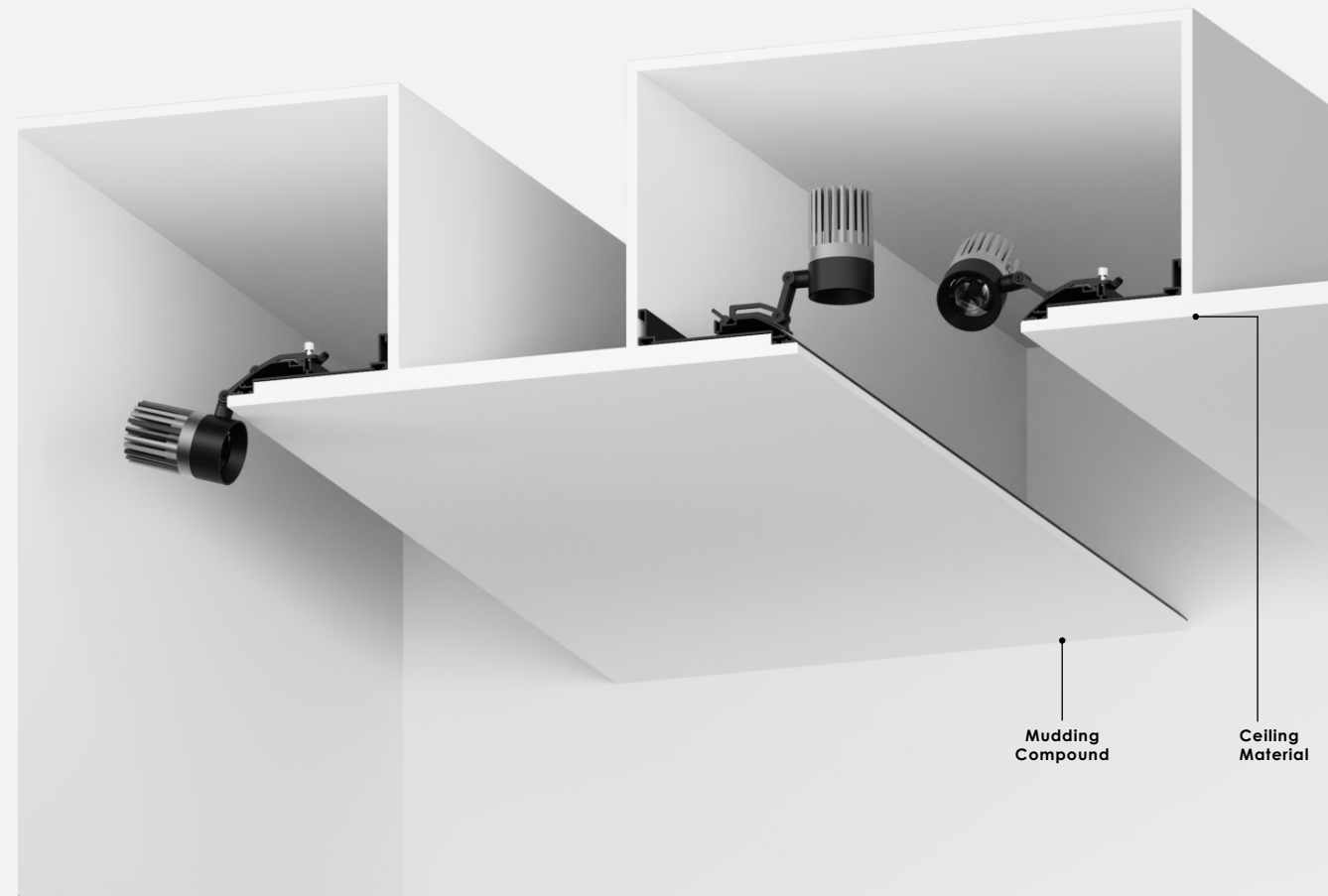

Scout Configuration

Profile And Corner Specifications

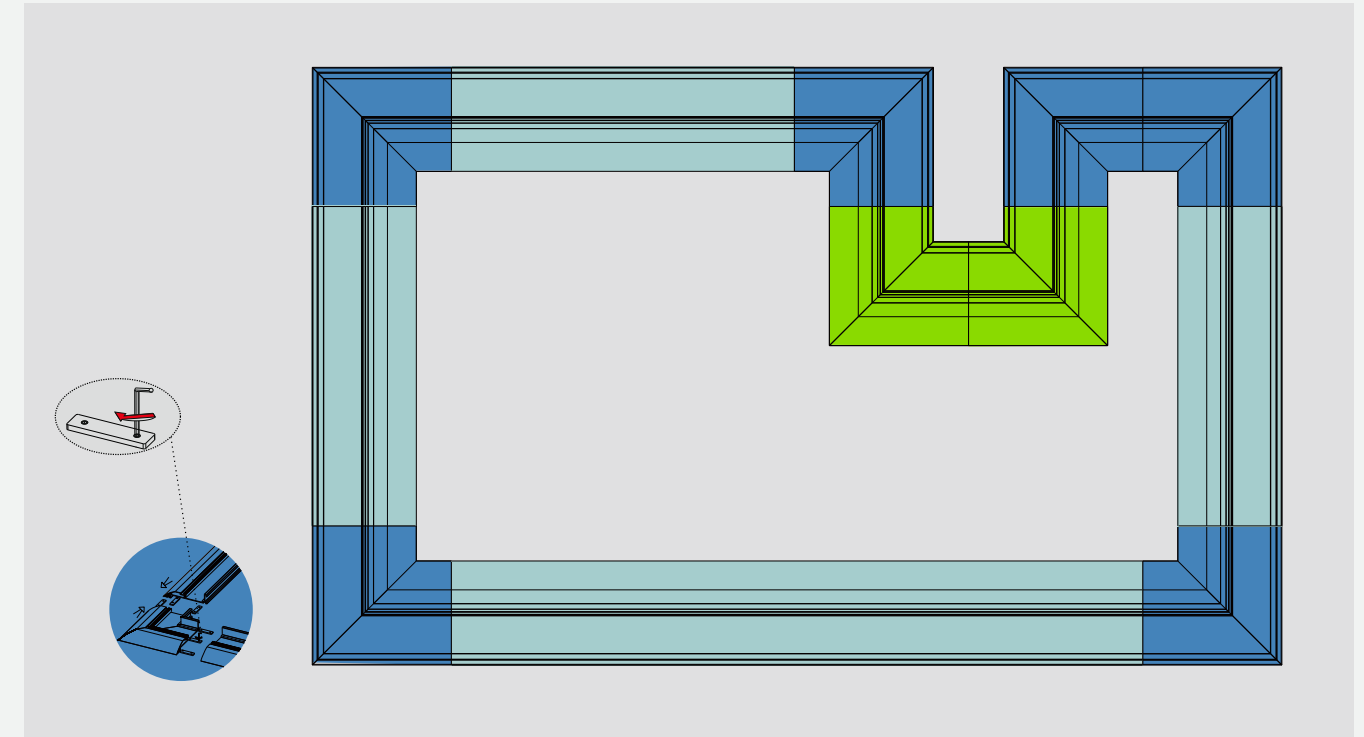

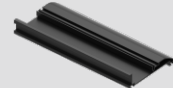
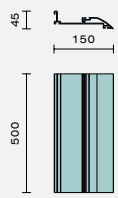
Profile Specification	TRACK LENGTH	White	Black
	500mm	24.0500.WH	24.0500.BK
	1000mm	24.1000.WH	24.1000.BK
	2000mm	24.2000.WH	24.2000.BK

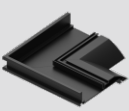
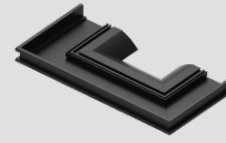
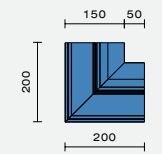
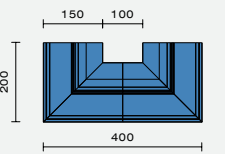
90° Inner Corner Specification	Double Inner Corner Specifications
	
	
24.00B0.BK	24.00D0.BK

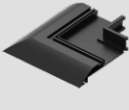
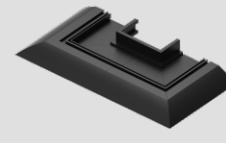
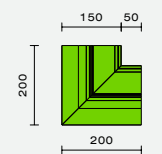
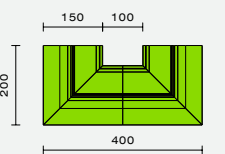
90° Outer Corner Specification	Double Outer Corner Specifications
	
	
24.00C0.BK	24.00E0.BK

Scout

Track Mounted Luminaire



Scout Track Mounted Luminaire

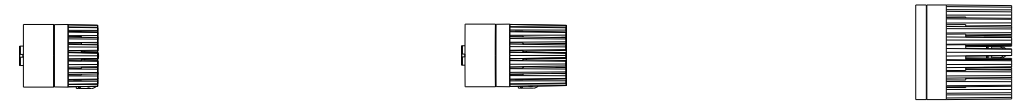
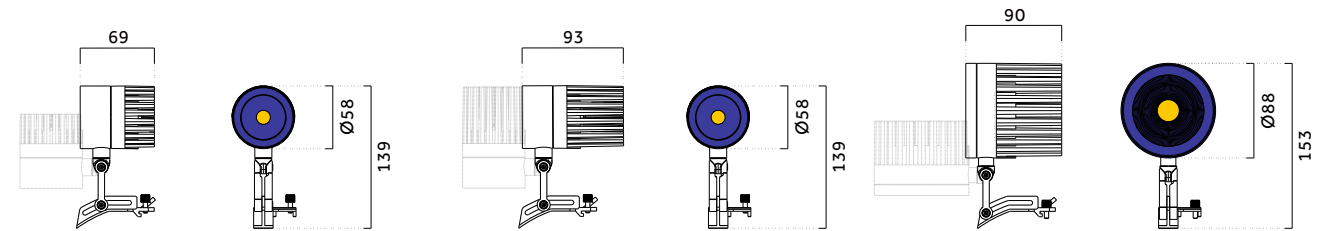
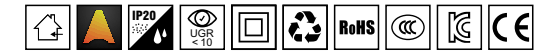

Code ordering example: $\underline{\quad}$ * * . $\underline{6020}$. * * * * * * * * (Max.12W) $\underline{\quad}$ * * . $\underline{8801}$. * * * * * * * * (Max.30W)
 $\underline{\quad}$ * * . $\underline{6030}$. * * * * * * * * (Max.15W)

	Product code	LED Power	Nominal Lumen	Finish	Cup	Beam Angle (BA°)	CCT Options	Dimming Options
Scout	20 220V	Max.12W	1200lm	W White	W White	15 15°	27 2700K	0 ON/OFF
3 Phase Track		Max.15W	1500lm	B Black	B Black	24 24°	30 3000K	1 0-10V
4 Phase Track		Max.30W	3000lm			36 36°	35 3500K 40 4000K	D DAIL T TRIAC C CASAMBI

Scout Track

Slotting And Fixing Diagram

Top view

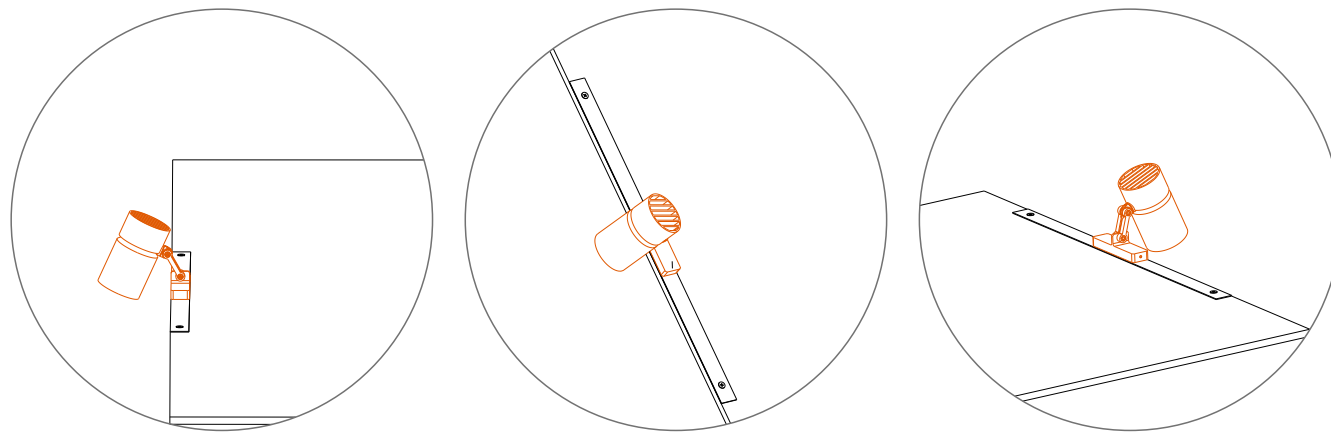
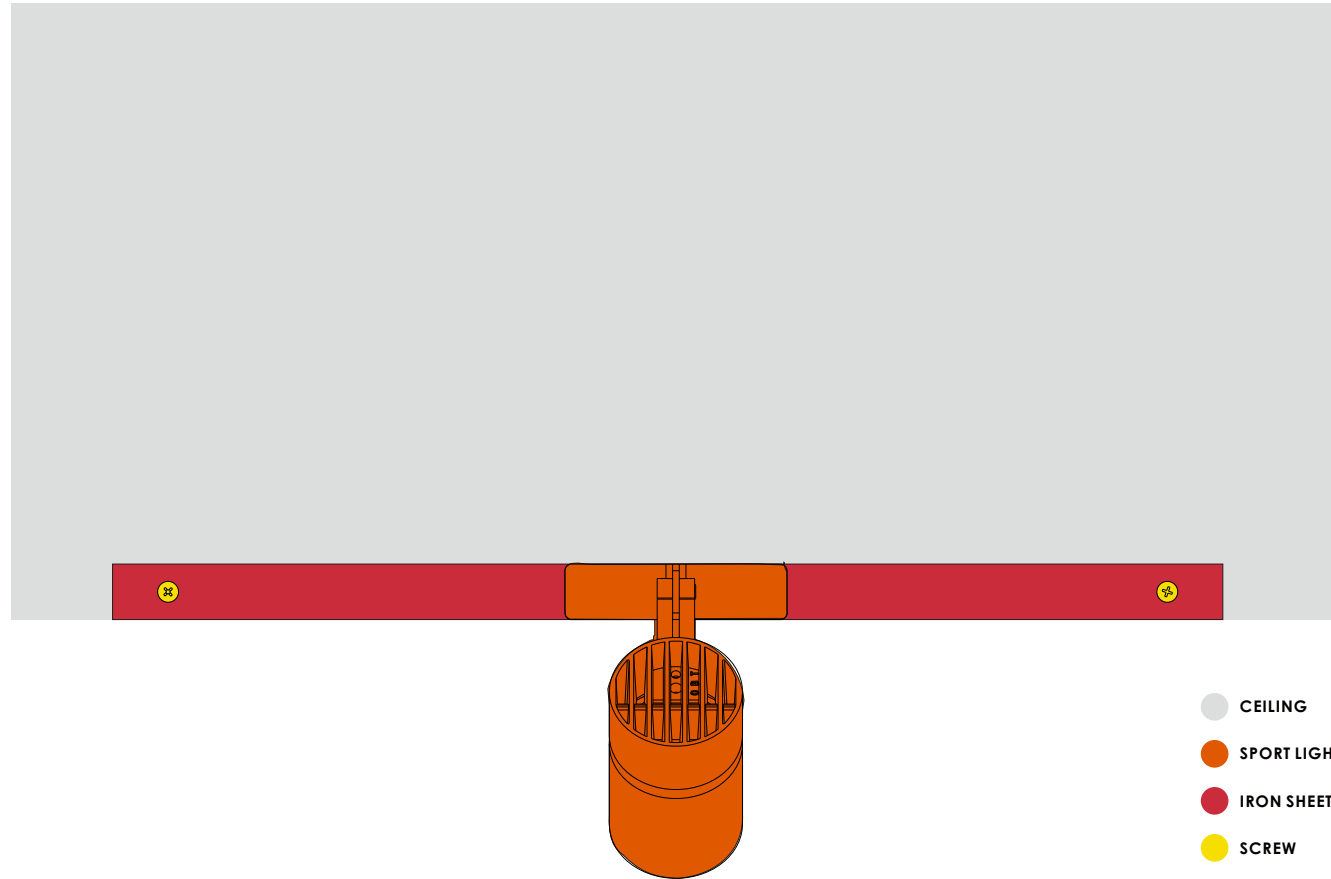

After fixing the iron sheet, the magnetic suction lamp is installed on the iron sheet .

Scout Track Mounted Luminaire

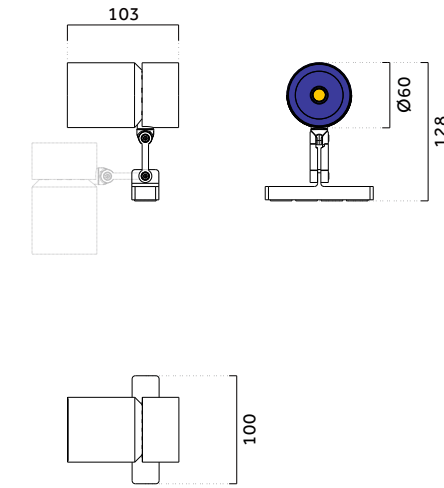
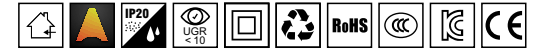

Code ordering example: * * . 6 0 1 2 . * * * * * *

	Product code	LED Power	Nominal Lumen	Finish	Cup	Beam Angle (BA°)	CCT Options	Dimming Options
Scout	20 220V	Max.15W	1350lm	W White	W White	15 15°	27 2700K	0 ON/OFF
Magnetic				B Black	B Black	24 24° 36 36°	30 3000K 35 3500K 40 4000K	1 0-10V D DAIL T TRIAC C CASAMBI

Scout

Track Mounted Luminaire



Scout Track Mounted Luminaire

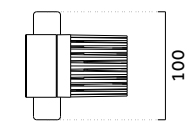
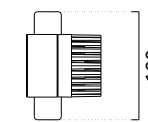
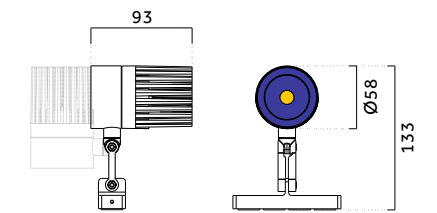
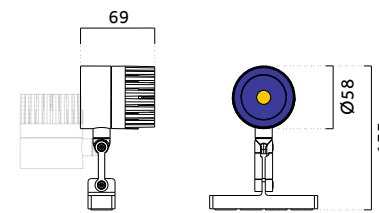
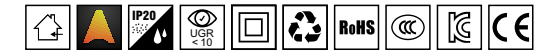

Code ordering example: **** . 6 0 0 1 . * * * * *** (Max.12W) **** . 8 8 0 2 . * * * * *** (Max.15W)

	Product code	LED Power	Nominal Lumen	Finish	Cup	Beam Angle (BA°)	CCT Options	Dimming Options
Scout	20 220V	Max.12W	1200lm	W White	W White	15 15°	27 2700K	0 ON/OFF
Magnetic		Max.15W	1500lm	B Black	B Black	24 24° 36 36°	30 3000K 35 3500K 40 4000K	1 0-10V D DAIL T TRIAC C CASAMBI

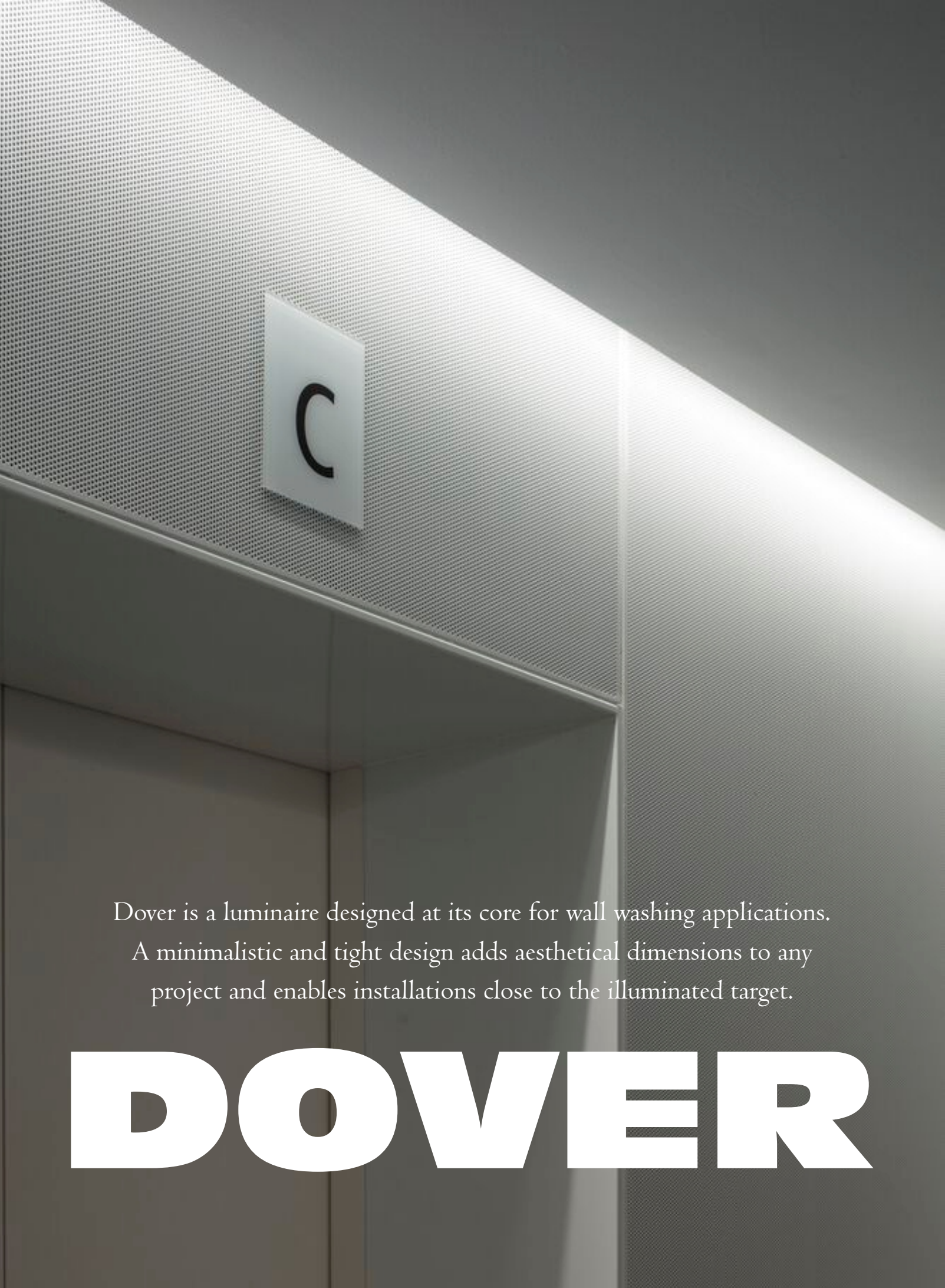

Dover is a luminaire designed at its core for wall washing applications. A minimalistic and tight design adds aesthetical dimensions to any project and enables installations close to the illuminated target.

DOVER

Dover

Wallwasher Luminaires

DOVER Series are OBT's answer for indoor linear light options with IP Rating of IP20. It has been designed for facade and similar applications. It comes with various lengths, 25mm,50mm, 300mm, 600mm, 900mm and 1200mm and beam angles 25x45°, which will meet wide range of application requirements.



Enable a precise cut off and perfect homogeneity



Outstanding CRI up to 90 and low glare.

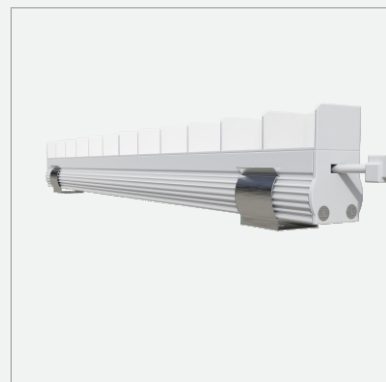

Minimally invasive (only 16 mm) and possibility to install close to the target.

Dover

Installation

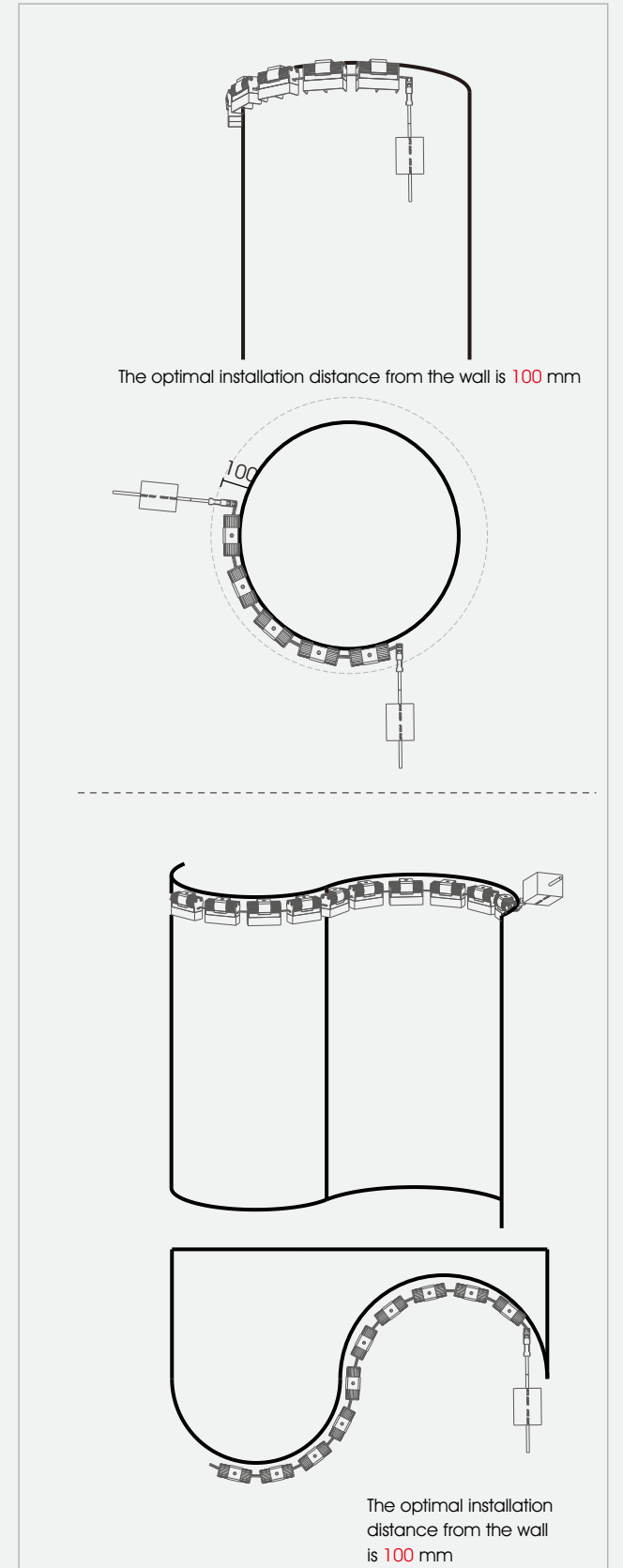
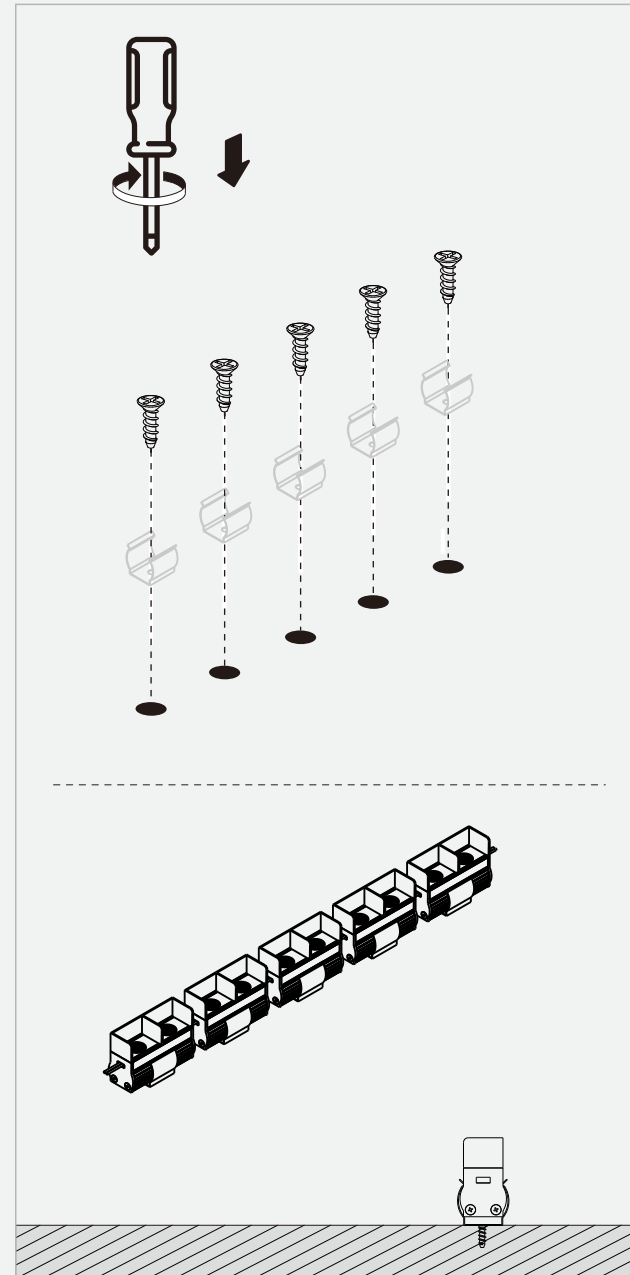

Dover

Wallwasher Luminaires



Dover Wallwasher Luminaires

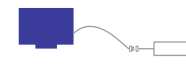
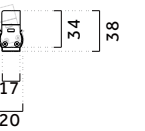
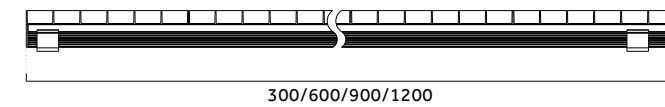

Code ordering example: $\frac{**}{**} \cdot \frac{1704}{**} \cdot \frac{*****}{**}$ (Max.6W) $\frac{**}{**} \cdot \frac{1707}{**} \cdot \frac{*****}{**}$ (Max.12W)
 $\frac{**}{**} \cdot \frac{1710}{**} \cdot \frac{*****}{**}$ (Max.18W) $\frac{**}{**} \cdot \frac{1713}{**} \cdot \frac{*****}{**}$ (Max.24W)

	Product code	LED Power	Nominal Lumen	Finish	Cup	Beam Angle (BA°)	CCT Options	Dimming Options
Dover	33 24V	Max.6W	600lm	W White	W White	45 25°*45°	30 3000K	0 ON/OFF
Wallwasher		Max.12W	1200lm	B Black	B Black		35 3500K	1 0-10V
		Max.18W	1800lm				40 4000K	D DAIL
		Max.24W	2400lm					T TRIAC C CASAMBI

Showcase Spotlight Series



Designed
for signage
of architectonic

LumiPod

Revolutionary miniature series

Designed for shallow compact spaces, this series offers discreetly recessed miniature connectors that conceal cables and form the base on which energy-efficient, high performance lightheads can be easily attached.

An easy to install, genuine plug & play system with complete flexibility, modular design and toolless magnetic connection. Ideal for application areas that require showcase and focus lighting solutions such as museums and retail.



Tool-free installation

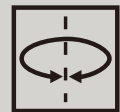

Tool-free installation
360° horizontal rotation



25° degree tilting

Adaptability & Simplicity



LumiPod

Adjustable Recessed



LumiPod

Adjustable Recessed

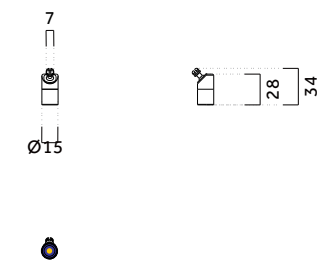
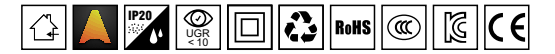

Code ordering example: * * . 1 5 0 1 . * * * * * *

	Product code	LED Power	Nominal Lumen	Finish	Cup	Beam Angle (BA°)	CCT Options	Dimming Options
LumiPod	03 Trim	Max.2W	160lm	W White	W White	15 15°	27 2700K	0 ON/OFF
Round				B Black	B Black	24 24°	30 3000K	1 0-10V
Adjustable					C Chrome	36 36°	35 3500K	D DAIL
							40 4000K	T TRIAC
							TW 2700K-6500K	C CASAMBI

Micro Track

24V Low Voltage Track

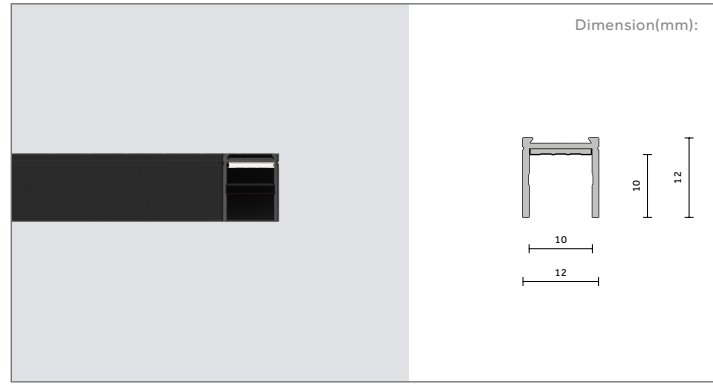

TRACK LENGTH	White	Black
1000mm	38.1210.WH	38.1210.BK
2000mm	38.1220.WH	38.1220.BK
3000mm	38.1230.WH	38.1230.BK

* A 350W driver is required to power up a single track (maximum length: 10m) with a maximum load of 170W per track.



Micro Track

24V Low Voltage Track

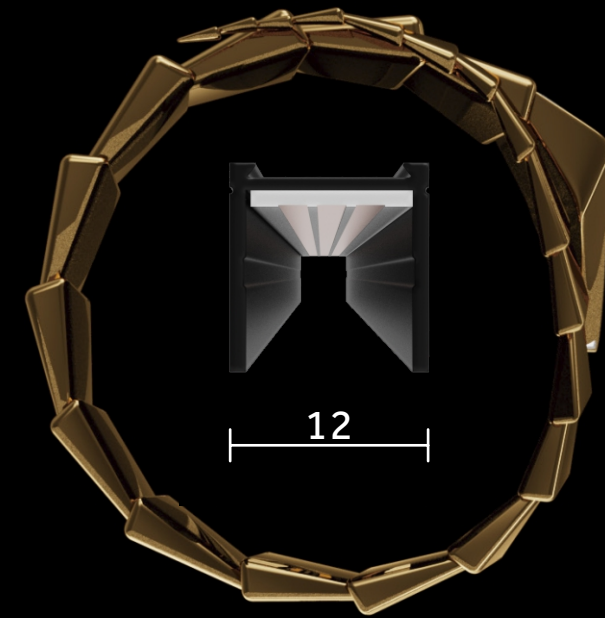

Electromechanical profile of reduced size for installation on surfaces with lengths from 1 to 3 m.

Fastening accessories included with the profiles.

The accessories usually is black 90° corners available in the same plane

(symmetrical element for left and right corners).

Micro Cylinder

24V Low Voltage Track



Micro Cylinder 24V Low Voltage Track

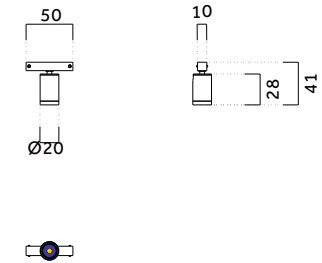
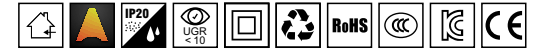

Code ordering example: * * . 2 0 0 1 . * * * * * *

	Product code	LED Power	Nominal Lumen	Finish	Cup	Beam Angle (BA°)	CCT Options	Dimming Options
Micro Cylinder	32 24V	Max.3W	240lm	W White	W White	15 15°	27 2700K	0 ON/OFF
24V Track				B Black	B Black	24 24°	30 3000K	1 0-10V
					C Chrome	36 36°	35 3500K	D DAIL
							40 4000K	T TRIAC
							TW 2700K-6500K	C CASAMBI

Micro Cylinder

24V Low Voltage Track



Micro Cylinder 24V Low Voltage Track

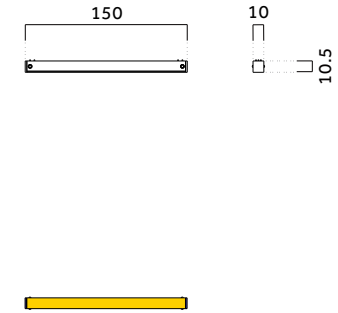
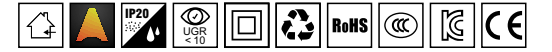

Code ordering example: . .

	Product code	LED Power	Nominal Lumen	Finish	Cup	Beam Angle (BA°)	CCT Options	Dimming Options
Micro Cylinder	30 24V	Max.3W	240lm	W White	W White	11 110°	27 2700K	0 ON/OFF
24V Track				B Black	B Black		30 3000K 35 3500K 40 4000K TW 2700K-6500K	1 0-10V D DAIL T TRIAC C CASAMBI

Micro Cylinder

24V Low Voltage Track



Micro Cylinder 24V Low Voltage Track

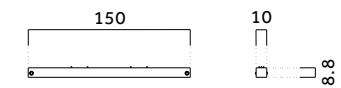
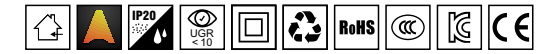

Code ordering example: * * . 1 0 0 8 . * * * * * *

	Product code	LED Power	Nominal Lumen	Finish	Cup	Beam Angle (BA°)	CCT Options	Dimming Options
Micro Cylinder	31 24V	Max.3W	240lm	W White	W White	15 15°	27 2700K	0 ON/OFF
24V Track				B Black	B Black	24 24°	30 3000K	1 0-10V
						36 36°	35 3500K	D DAIL
						48 48°	40 4000K	T TRIAC
							TW 2700K-6500K	C CASAMBI



MTA
Wallwasher Luminaires

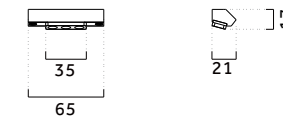
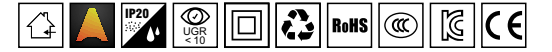

Code ordering example: . .

	Product code	LED Power	Nominal Lumen	Finish	Cup	Beam Angle (BA°)	CCT Options	Dimming Options
MTA	57 24V	Max.3W	240lm	W White	W White	62 62°	30 3000K	0 ON/OFF
Magnetic				B Black	B Black		35 3500K 40 4000K	1 0-10V D DAIL T TRIAC C CASAMBI

Microline

Linear profile lighting luminaire



Microline 8 X 10 Corner

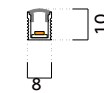

Code ordering example: . 0 8 0 1 .

	Product code	LED Power	Nominal Lumen	Finish	Cup	Beam Angle (BA°)	CCT Options	Dimming Options
Microline	56 24V	Max.12W/m	1200lm	B Black	W White	11 110°	27 2700K	0 ON/OFF
8 x 10mm				C Chrome	B Black		30 3000K 35 3500K 40 4000K TW 2700K-6500K	1 0-10V D DAIL T TRIAC C CASAMBI

Microline

Linear profile lighting luminaire



Microline 8 X 11.5 Corner

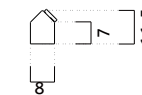
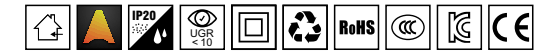

Code ordering example: . .

	Product code	LED Power	Nominal Lumen	Finish	Cup	Beam Angle (BA°)	CCT Options	Dimming Options
Microline	57 24V	Max.12W/m	1200lm	B Black	W White	11 110°	27 2700K	0 ON/OFF
8 x 11.5mm				C Chrome	B Black		30 3000K 35 3500K 40 4000K TW 2700K-6500K	1 0-10V D DAIL T TRIAC C CASAMBI

Microline

Linear profile lighting luminaire



Microline 15 X 9 Corner

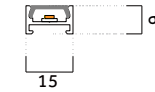
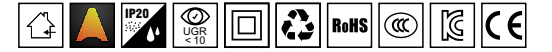

Code ordering example: . 1 5 0 1 .

	Product code	LED Power	Nominal Lumen	Finish	Cup	Beam Angle (BA°)	CCT Options	Dimming Options
Microline	56 24V	Max.12W/m	1200lm	B Black	W White	11 110°	27 2700K	0 ON/OFF
15 x 9mm				C Chrome	B Black		30 3000K 35 3500K 40 4000K TW 2700K-6500K	1 0-10V D DAIL T TRIAC C CASAMBI

Flexible Side Bend Linear Luminaire

A high-quality silicone profile with Integrated lighting, which has been designed to offer maximum flexibility and adaptability. Thanks to its ability to curve both vertically and horizontally, this neon adapts to any design, enabling the creation of innovative shapes.

Our 3D MTA comes with an opaline front and a silky finish, which not only adds an elegant aesthetic but also repels dust and dirt, ensuring uniform lighting.

Made from gaseous silica gel, this profile offers superior protection against moisture, high temperatures and environmental wear. It is highly resistant to yellowing, UV rays and salt corrosion. Additionally, it features flame-retardant properties for added safety. With an IP67 protection rating and UV resistance, it is perfect for both outdoor use and humid areas, ensuring durability..

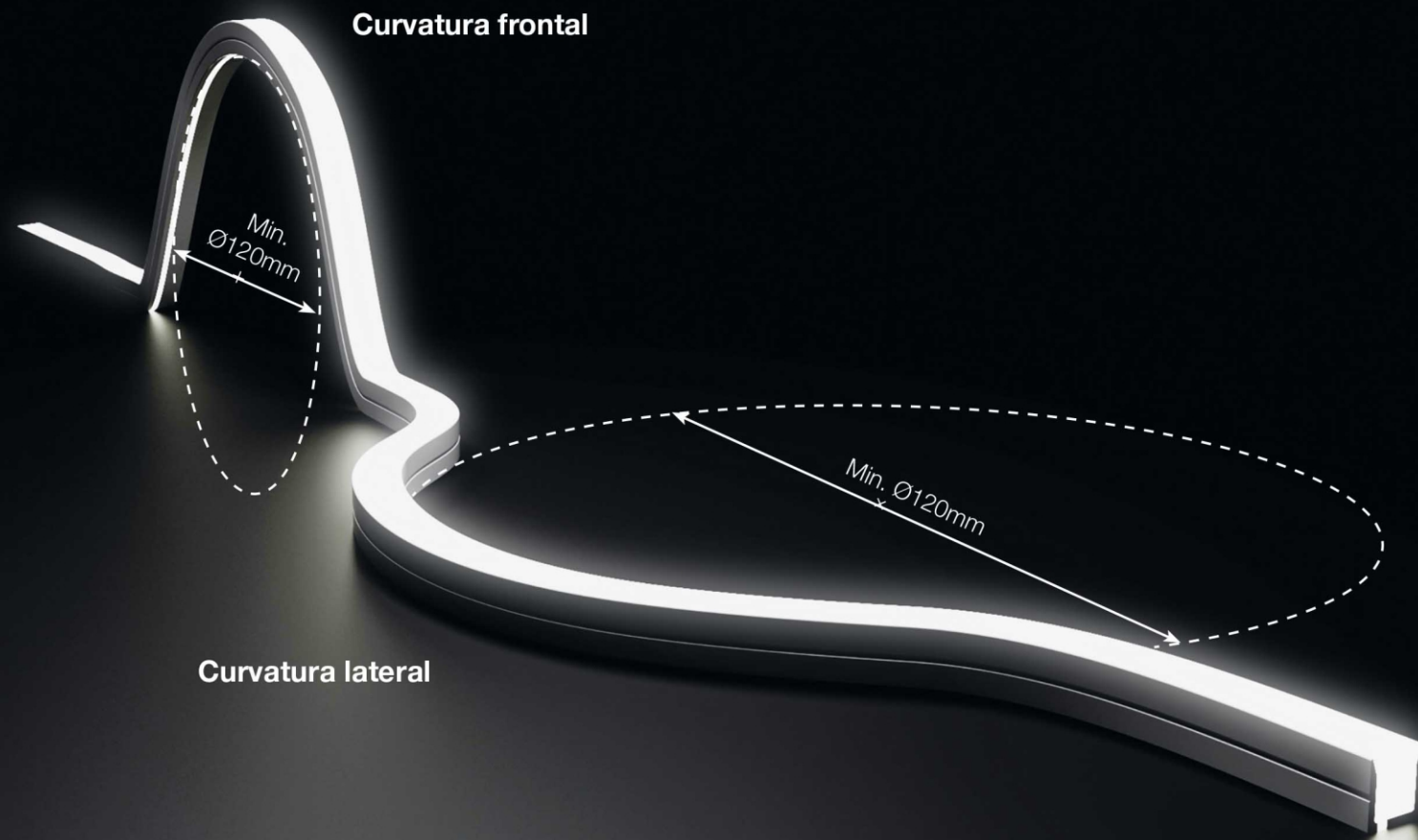

LED linear lighting system

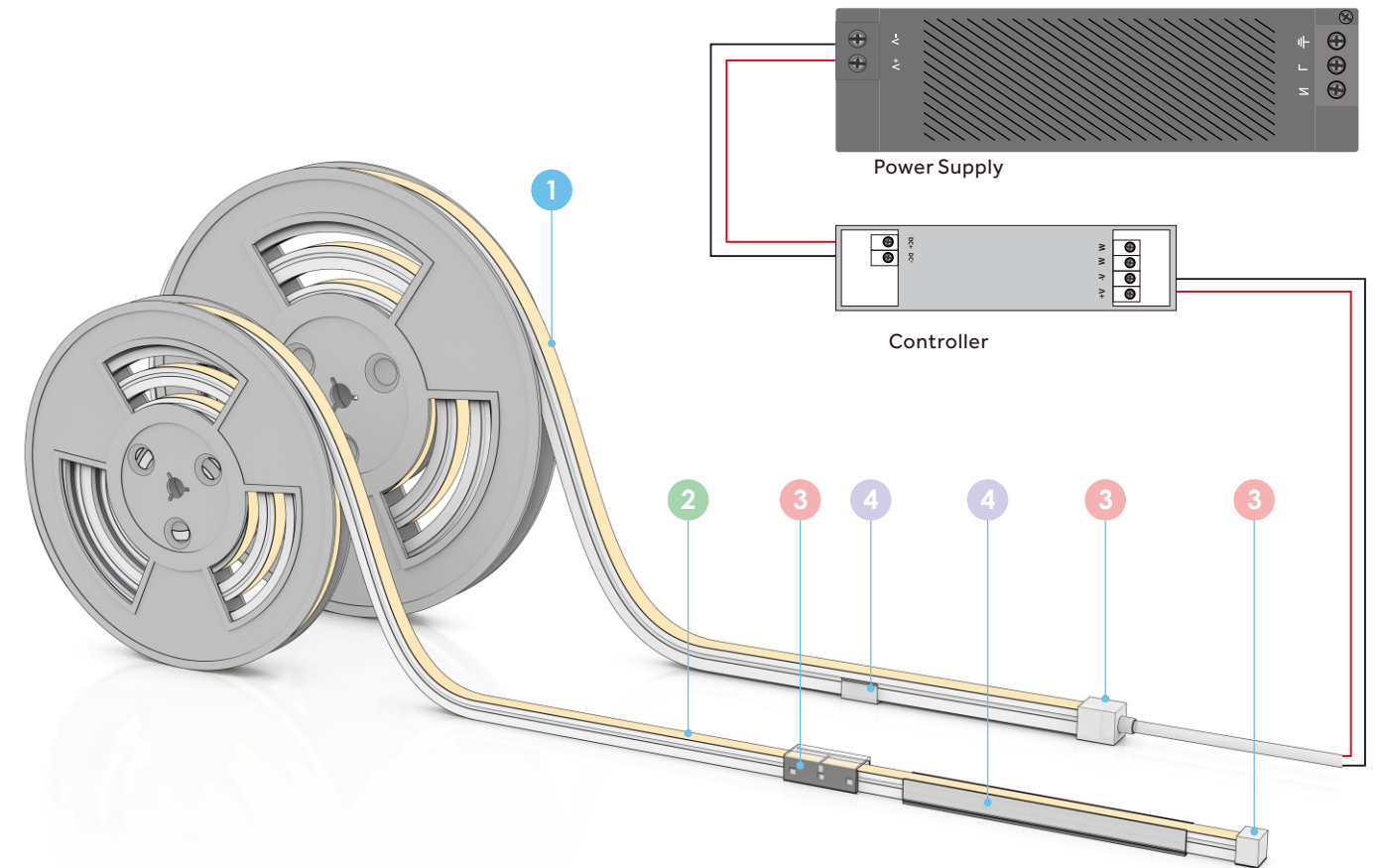

1 LED Strip Light

- Single Color
- Common Anode Adjustable CCT
- Polarity Adjustable CCT
- RGB
- PIXEL
- RGB+W

2 LED Light Source

- SMD2835 / SMD2216 / SMD3838 / SMD5050
- CRI > 90 CRI > 95
 - 2700K 3000K 4000K 4500K 5000K 6000K

3 Connection Method

- End Cap (top wire outlet)
- End Cap (bottom wire outlet)
- End Cap (side wire outlet)
- No Welding Connector

4 Installs Way

- S Type Buckle
- Fixed Clip
- Aluminium Profile

Microline

Linear profile lighting luminaire



Microline

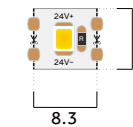
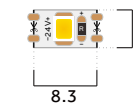

Code ordering example: . 8 3 0 5 . * * * * * * (Max.8W) . 8 3 0 8 . * * * * * * (Max.12W)

	Product code	LED Power	Nominal Lumen	LEDs/meter	Cutting Unit	Beam Angle (BA°)	CCT Options	Dimming Options
Microline	40 24V	Max.8W/m	800lm	12 120LEDs	1leds/15mm	11 110°	27 2700K	0 ON/OFF
		Max.12W/m	1200lm				30 3000K	1 0-10V
							35 3500K	D DAIL
							40 4000K	T TRIAC
							TW 2700K-6500K	C CASAMBI

Microline

Linear profile lighting luminaire



Microline 12 X 12 Corner

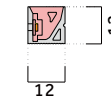
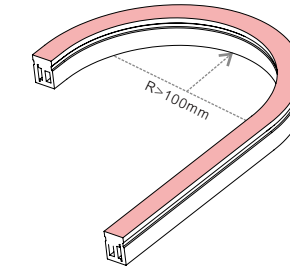
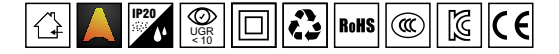

Code ordering example: . .

	Product code	LED Power	Nominal Lumen	Finish	Cup	Beam Angle (BA°)	CCT Options	Dimming Options
Microline	59 24V	Max.12W/m	1200lm	W White	W White	11 110°	27 2700K	0 ON/OFF
8 x 8mm							30 3000K	1 0-10V
							35 3500K	D DAIL
							40 4000K	T TRIAC
							TW 2700K-6500K	C CASAMBI



B-O
Wall Recessed

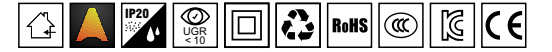

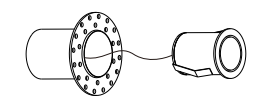
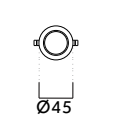
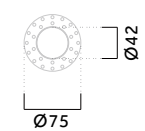
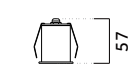

Ø46mm



Code ordering example: . .

	Product code	LED Power	Nominal Lumen	Finish	Cup	Beam Angle (BA°)	CCT Options	Dimming Options
B-O	05 24V	Max.2W	120lm	W White	W White	72 72°	27 2700K	0 ON/OFF
Wall Recessed				B Black	B Black		30 3000K 35 3500K 40 4000K	1 0-10V D DAIL T TRIAC C CASAMBI

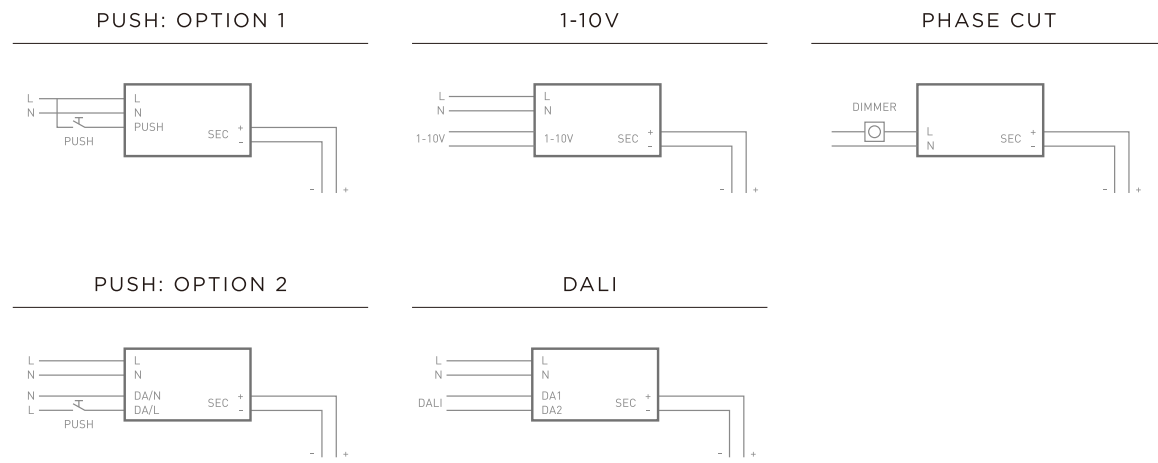
Installation Schemes



Connection Tips

SEVERAL FIXTURES CONNECTION TO A SINGLE CONSTANT CURRENT DRIVER

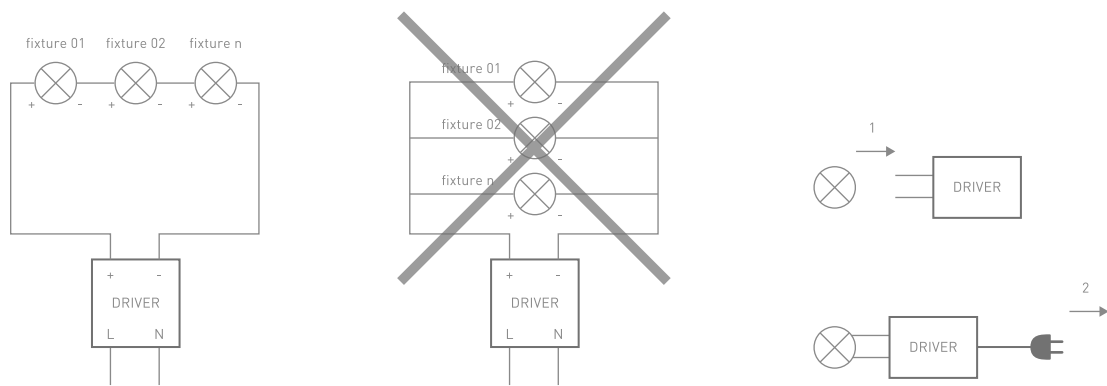

Trimless Mounting

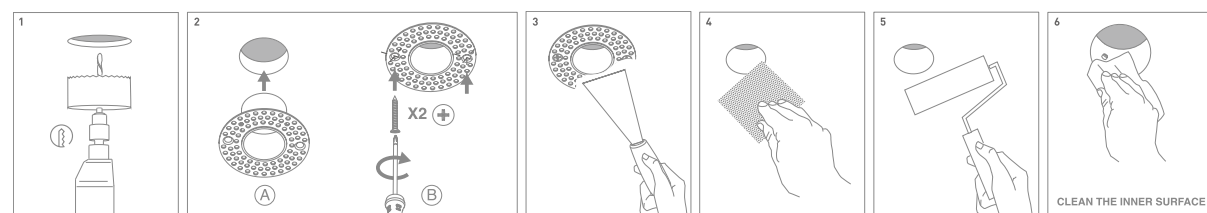

Publication date: December 2025

©Copyright OBT Lighting

Thanks to all contributors for the realization of this catalogue.

Designed by the Graphic Design Department of OBT Lighting.

No part of this catalogue may be reproduced without the written authorization of OBT Lighting.



OBT LIGHTING LIMITED

Unit G1 Capital House 61
Amhurst Road, London,
United Kingdom, E8 1LL
Hotline : 400 090 2289
Email : obt@obt.ltd

www.obt.ltd

Office 5, 8/F, Mega Cube,
8 Wang Kwong Road, Kowloon
Bay, Kowloon, Hong Kong
Hotline : 400 090 2289
Email : obt@obt.ltd

www.obt.ltd



Floor 2, No. 979, Yunhan
Road, Lingang New District,
China (Shanghai) pilot Free
Trade Zone
Hotline : 400 090 2289
Email : obt@obt.ltd

www.obt.ltd

Room 201, building 3, No. 67,
Luoja Nanyue street, Dalong
street, Panyu District,
Guangzhou
Hotline : 400 090 2289
Email : obt@obt.ltd

www.obt.ltd