

# 02

**SCOUT  
SERIES**





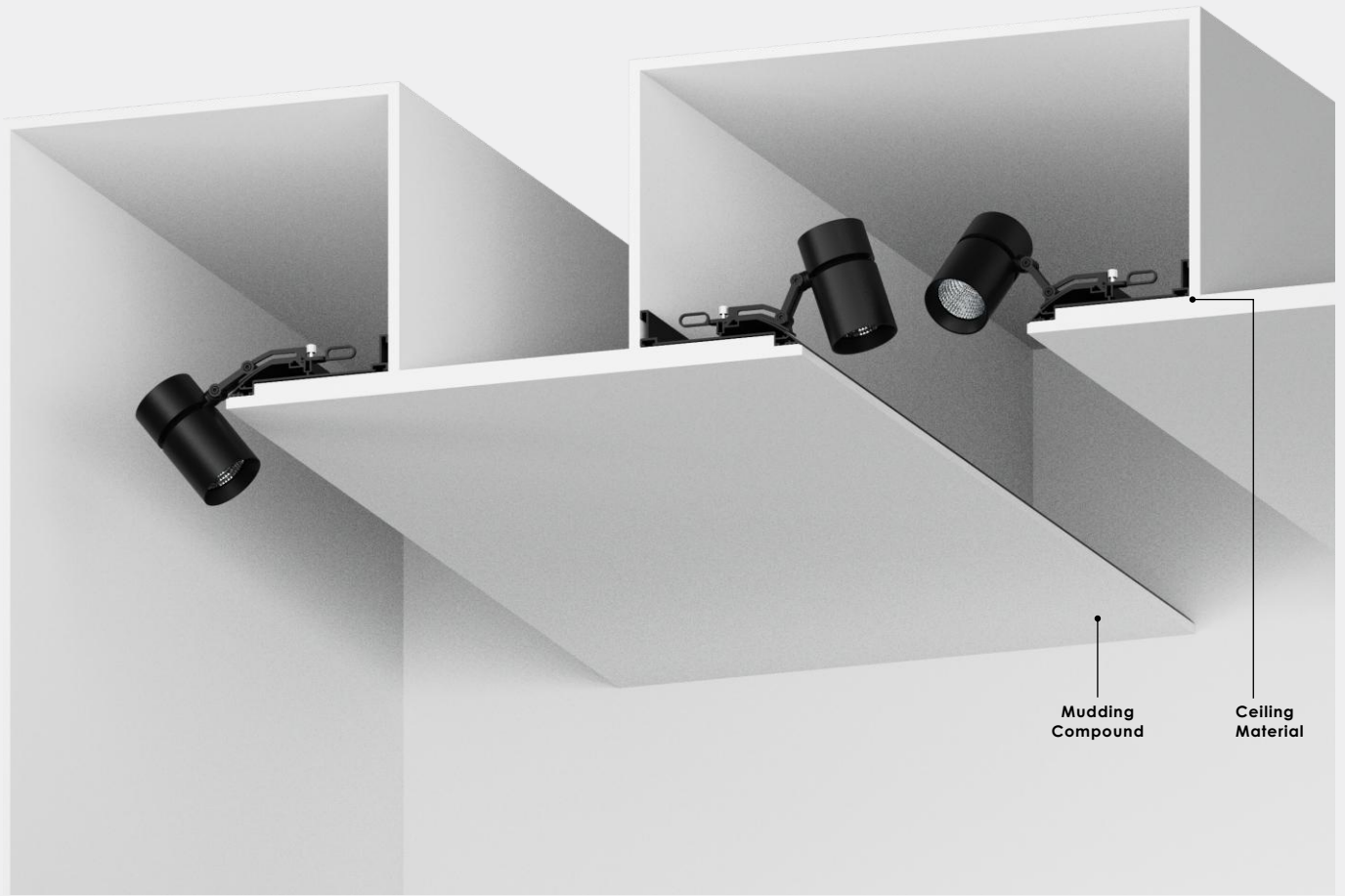
LIGHTS  
THAT  
CHANGE

**EVERYTHING**

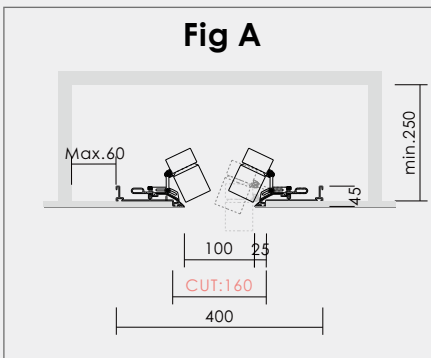


# SCOUT TRACK

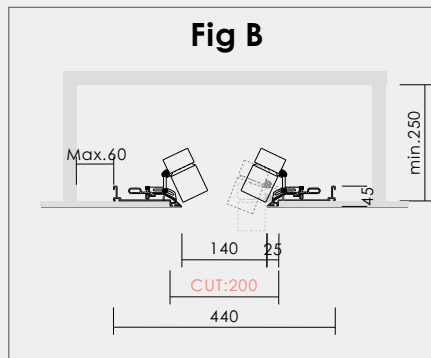
## SLOTTING AND FIXING DIAGRAM



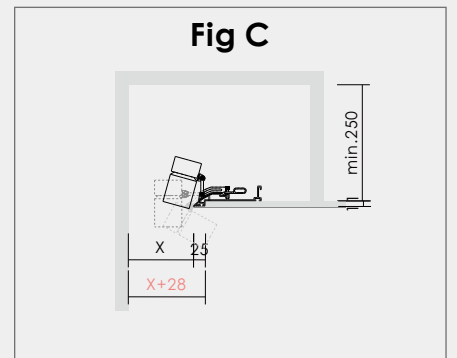
**Fig A**



**Fig B**

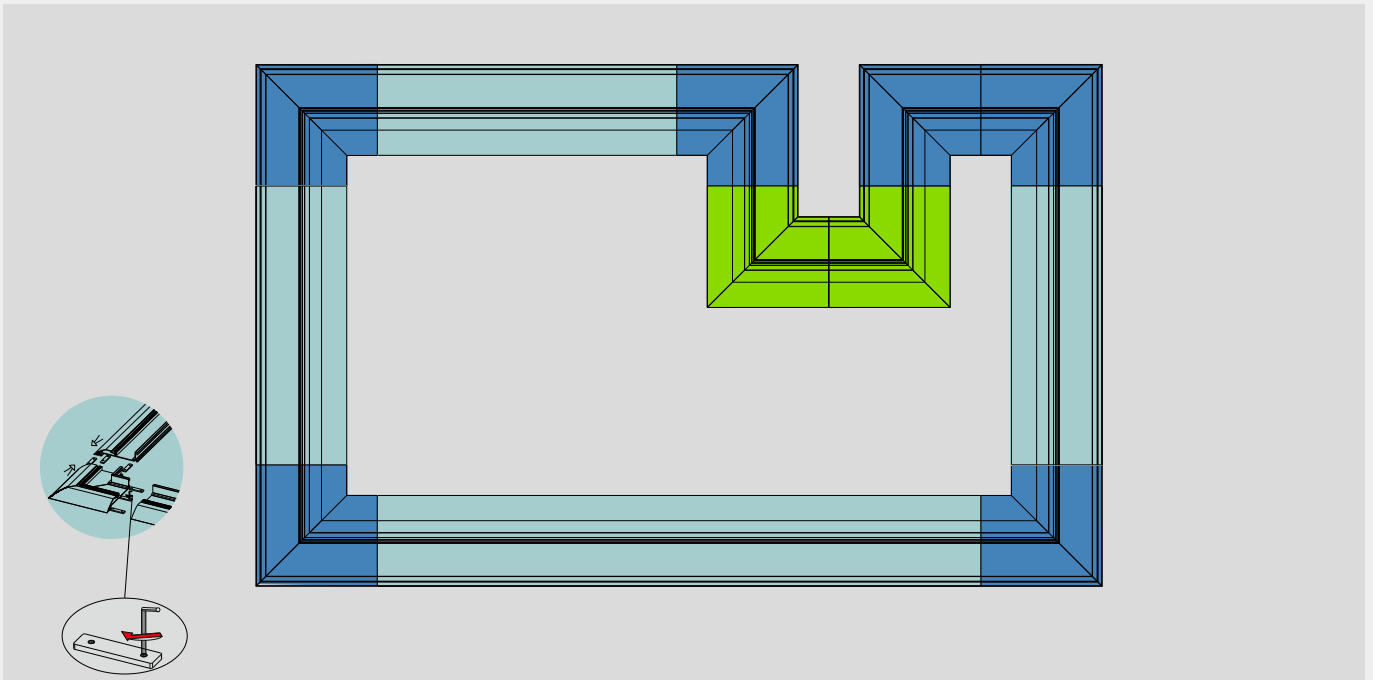


**Fig C**

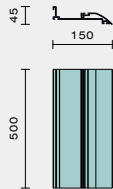
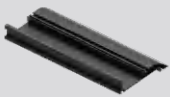


# SCOUT CONFIGURATION

## PROFILE AND CORNER SPECIFICATIONS



### Profile Specification



### TRACK LENGTH

500mm  
1000mm  
2000mm

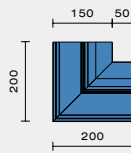
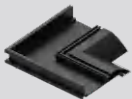
### White

24.0500.WH  
24.1000.WH  
24.2000.WH

### Black

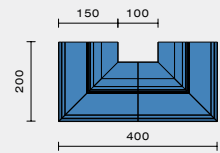
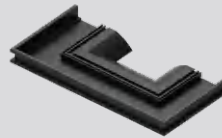
24.0500.BK  
24.1000.BK  
24.2000.BK

### 90° Inner Corner Specification



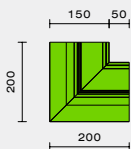
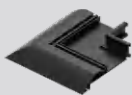
24.00B0.BK

### Double Inner Corner Specifications



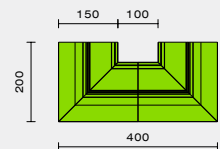
24.00D0.BK

### 90° Outer Corner Specification












24.00C0.BK

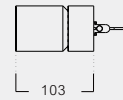
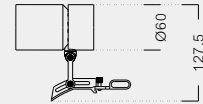
### Double Outer Corner Specifications



24.00E0.BK

# Scout

-  Ceiling Track
-  AC 220V~240V
-  Ra 95
-  Reflector
-  Class II
-  0°~90°
-  0°~355°
-  White (WH)
-  Black (BK)












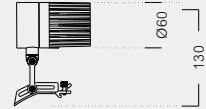
Wattage	Beam Angle	2700K	3000K	3500K	4000K
Max. 15W	15°	20.6001.WH 20.6001.BK	20.6002.WH 20.6002.BK	20.6028.WH 20.6028.BK	20.6003.WH 20.6003.BK
	24°	20.6004.WH 20.6004.BK	20.6005.WH 20.6005.BK	20.6029.WH 20.6029.BK	20.6006.WH 20.6006.BK
	36°	20.6007.WH 20.6007.BK	20.6008.WH 20.6008.BK	20.6030.WH 20.6030.BK	20.6009.WH 20.6009.BK

Dimming: On/Off, 1-10V, DALI  
 UGR: ≤15  
 SDCM: ≤3  
 Luminous efficacy: 80lm/W  
 luminaire Lifetime: 50000h ( L80B10, T a25° C )  
 Material: Aluminium  
 Working Temperature ( °C): -20° C ~ +45° C  
 Transformer availability: LED DC 36V 350mA



# Scout

-  Ceiling Track
-  AC 220V~240V
-  Ra 95
-  Reflector
-  Class II
-  0°~90°
-  0°~355°
-  White (WH)
-  Black (BK)



Wattage	Beam Angle	2700K	3000K	3500K	4000K
Max. 15W	15°	20.6019.WH 20.6019.BK	20.6020.WH 20.6020.BK	20.6034.WH 20.6034.BK	20.6021.WH 20.6021.BK
	24°	20.6022.WH 20.6022.BK	20.6023.WH 20.6023.BK	20.6035.WH 20.6035.BK	20.6024.WH 20.6024.BK
	36°	20.6025.WH 20.6025.BK	20.6026.WH 20.6026.BK	20.6036.WH 20.6036.BK	20.6027.WH 20.6027.BK

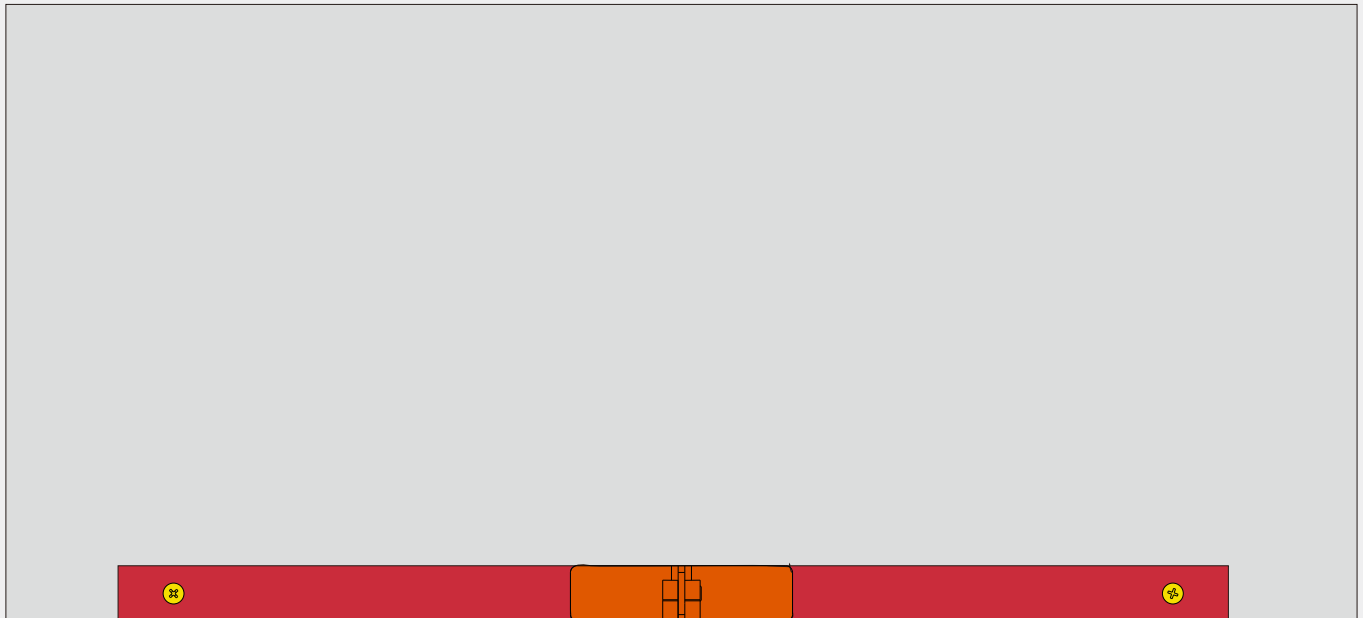
Dimming: On/Off, 1-10V, DALI  
 UGR: ≤15  
 SDCM: ≤3  
 Luminous efficacy: 80lm/W  
 luminaire Lifetime: 50000h ( L80B10, T a25° C )  
 Material: Aluminium  
 Working Temperature ( °C): -20° C ~ +45° C  
 Transformer availability: LED DC 36V 350mA



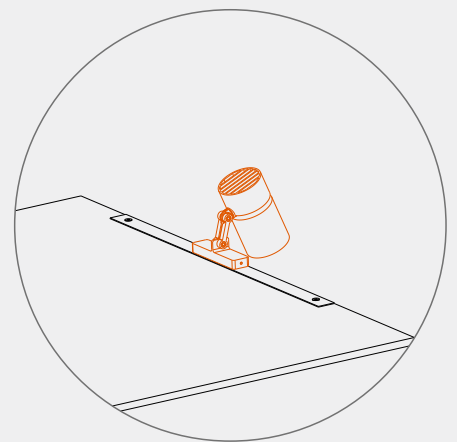
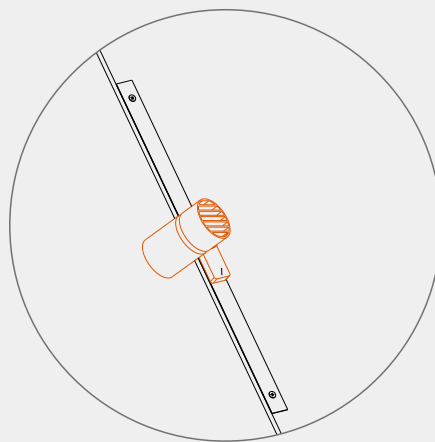
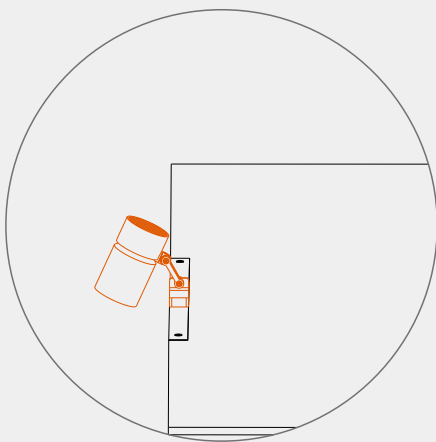
# SCOUT TRACK

## SLOTING AND FIXING DIAGRAM

Top view












- CEILING
- SPORT LIGHT
- IRON SHEET
- SCREW

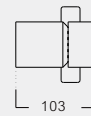
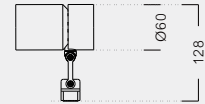


After fixing the iron sheet, the magnetic suction lamp is installed on the iron sheet.



# Scout

-  Ceiling Track
-  AC 220V~240V
-  Ra 95
-  Reflector
-  Class II
-  0°~90°
-  0°~355°
-  White (WH)
-  Black (BK)












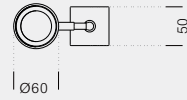
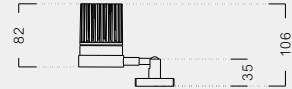
Wattage	Beam Angle	2700K	3000K	3500K	4000K
Max. 15W	15°	20.6010.WH 20.6010.BK	20.6011.WH 20.6011.BK	20.6031.WH 20.6031.BK	20.6012.WH 20.6012.BK
	24°	20.6013.WH 20.6013.BK	20.6014.WH 20.6014.BK	20.6032.WH 20.6032.BK	20.6015.WH 20.6015.BK
	36°	20.6016.WH 20.6016.BK	20.6017.WH 20.6017.BK	20.6033.WH 20.6033.BK	20.6018.WH 20.6018.BK

Dimming: On/Off, 1-10V, DALI  
 UGR: ≤15  
 SDCM: ≤3  
 Luminous efficacy: 80lm/W  
 luminaire Lifetime: 50000h ( L80B10, T a25° C )  
 Material: Aluminium  
 Working Temperature ( °C): -20° C ~ +45° C  
 Transformer availability: LED DC 36V 350mA



# Scout

-  Ceiling Track
-  AC 220V~240V
-  Ra 95
-  Lens
-  Class II
-  0°~90°
-  0°~355°
-  White (WH)
-  Black (BK)

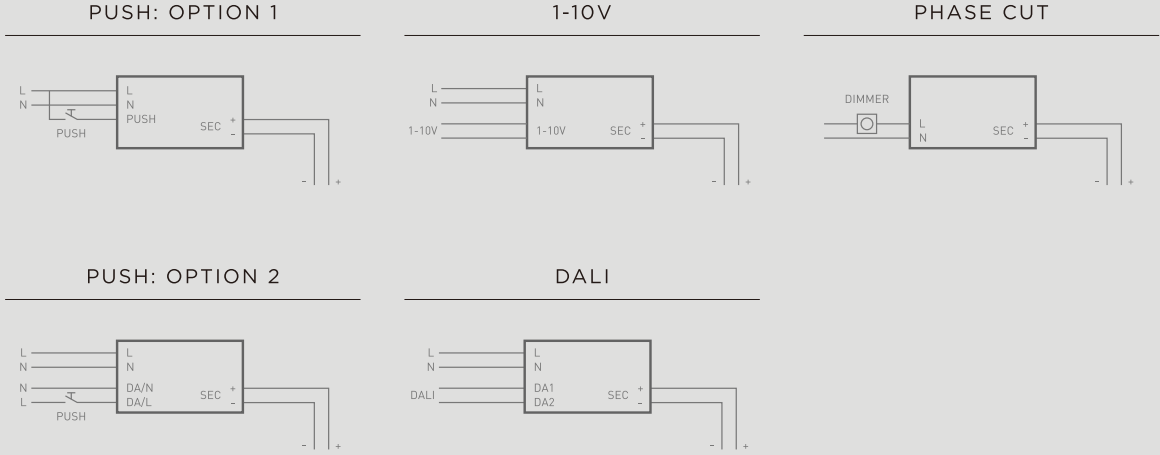


Wattage	Beam Angle	2700K	3000K	3500K	4000K
Max. 15W	15°	20.6037.WH 20.6037.BK	20.6038.WH 20.6038.BK	20.6039.WH 20.6039.BK	20.6040.WH 20.6040.BK
	24°	20.6041.WH 20.6041.BK	20.6042.WH 20.6042.BK	20.6043.WH 20.6043.BK	20.6044.WH 20.6044.BK
	36°	20.6045.WH 20.6045.BK	20.6046.WH 20.6046.BK	20.6047.WH 20.6047.BK	20.6048.WH 20.6048.BK

Dimming: On/Off, 1-10V, DALI  
 UGR: ≤15  
 SDCM: ≤3  
 Luminous efficacy: 80lm/W  
 luminaire Lifetime: 50000h ( L80B10, T a25° C )  
 Material: Aluminium  
 Working Temperature ( °C): -20° C ~ +45° C  
 Transformer availability: LED DC 36V 350mA

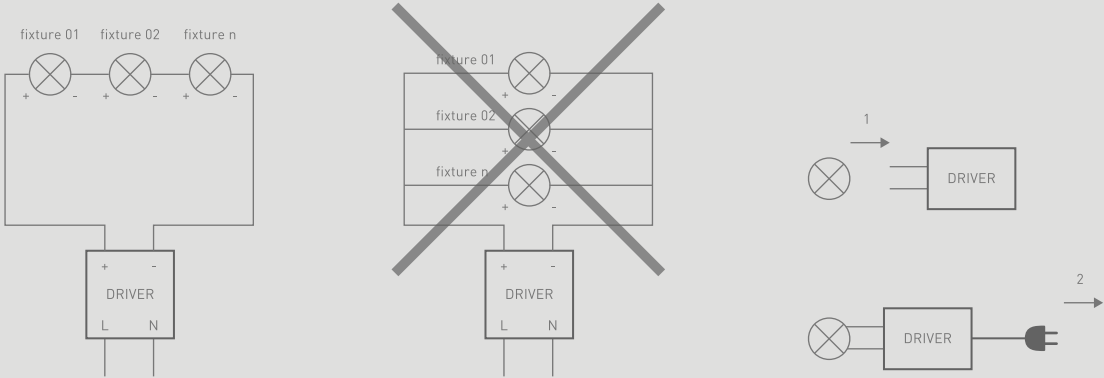


# Installation Schemes

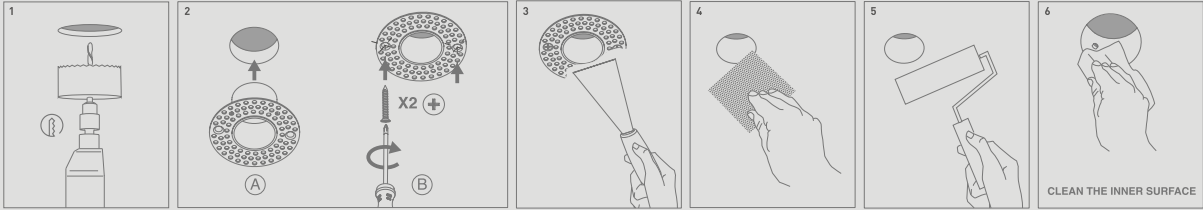


# Connection Tips

SEVERAL FIXTURES CONNECTION TO A SINGLE CONSTANT CURRENT DRIVER



# Trimless Mounting



*Publication date: December 2022*

*©Copyright OBT lighting*

*With thank to all contributors for the realization of this catalogue*

*Designed by OBT lighting Graphic Design Department*

*No part of this catalogue may be copied without written authorization of OBT lighting*



## **OBT LIGHTING LIMITED**

Unit G1 Capital House 61  
Amhurst Road, London,  
United Kingdom, E8 1LL  
services@obtlighting.cn  
Hotline : 400 090 2289

[www.obt.ltd](http://www.obt.ltd)



Floor 2, No. 979, Yunhan  
Road, Lingang New District,  
China (Shanghai) pilot Free  
Trade Zone  
services@obtlighting.cn  
Hotline : 400 090 2289

[www.obt.ltd](http://www.obt.ltd)

Office 5, 8/F, Mega Cube,  
8 Wang Kwong Road, Kowloon  
Bay, Kowloon, Hong Kong  
services@obtlighting.cn  
Hotline : 400 090 2289

[www.obt.ltd](http://www.obt.ltd)

Room 201, building 3, No. 67,  
Luoja Nanyue street, Dalong  
street, Panyu District,  
Guangzhou  
services@obtlighting.cn  
Hotline : 400 090 2289

[www.obt.ltd](http://www.obt.ltd)